

TEC

TEC Electronic Computing Scale

SL-5900 (US. Version)

Owner's Manual

Document No. EM1-31015

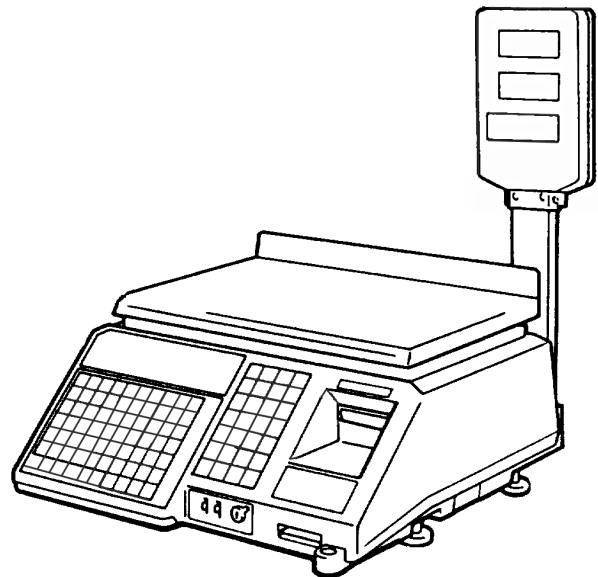

TOKYO ELECTRIC CO., LTD.

TABLE OF CONTENTS

	Page
● INTRODUCTION	1
1. SPECIFICATIONS	5
2. OVERVIEW	7
3. REMOTE DISPLAY	7
4. KEY LAYOUT	8
5. KEY FUNCTIONS	10
6. LAMP FUNCTIONS	13
7. CONTROL LOCK	14
8. LEVEL ADJUSTMENT	15
9. CLEANING THE PRINT HEAD	15
10. REMOVAL AND REPLACEMENT OF LABEL ROLL	16
11. REPORT PAPER THREADING	17
12. BEFORE STARTING OPERATION	17
13. OPERATING PROCEDURES	18
13.1 Weighed Commodity Registration	18
13.2 Fix Price Registration	21
13.3 By Count Registration (standard function)	22
13.4 By Count Registration (optional function by initial setting)	24
13.5 Tare Function Procedures	27
13.6 SAVE Key Operation Sample	28
13.7 VOID Key Operation Sample	29
13.8 Date Change	29
13.9 Calling And Printing A Grade Line	30
13.10 Entry By Clerk	31
13.11 Add Entry By Clerk	32
13.12 Multiple Weight	33

	Page
14. TOTAL OPERATION PROCEDURES	34
14.1 Hourly Total Report	34
14.2 Grand Total Report	35
14.3 PLU Total Report	36
14.4 Clerk Total Report	40
15. LIST UP OF PLU DATA	42
16. PROGRAMMING PROCEDURES	45
• Selection of Programming Menu	45
Menu No. 0 : Changing Unit Price or Price	46
Menu No. 1 : Setting or Changing PLU Data	47
Menu No. 2 : Setting Store Address or Commercial Message	52
Menu No. 3 : Adjusting Print Position for Label	53
Menu No. 4 : Setting Date, Time, Machine Number, and Store Number	54
Menu No. 5 : CMT Operations	55
Menu No. 7 : Changing Bar Code Format	57
Menu No. 8 : Assigning Speed Keys	60
Menu No. 11 : Setting Ingredient (for SL-5900-36 only)	61
Menu No. 12 : Issuing Confirmation Label (for SL-5900-35/36 only)	63
Menu No. 13 : Switching On-Line/Local (for SL-5900-35/36 only)	64
Menu No. 17 : Setting Grade Line (for SL-5900-36 only)	65
Menu No. 18 : Memory Card (for SL-5900-36 only)	66
Menu No. 20 : Transmitting PLU File or Unit Price (FUN System)	69
Menu No. 21 : Setting Clerk Name (for SL-5900-36 only)	70
Menu No. 40 : Setting Print Item #1 ON/OFF	72
Menu No. 41 : Setting Print Item #2 ON/OFF	73
17. ERROR MESSAGE TABLE	74
18. BEFORE YOU CALL FOR SERVICE	75

CAUTION:

1. *This manual may not be copied in whole or in part without prior written permission.*
2. *The contents of this manual may be changed without prior notice.*
3. *Please refer to your local Authorized Service representative with regard to any queries you may have in this manual.*

● INTRODUCTION

We thank you very much for purchasing the TEC Electronic Computing Scale SL-5900 Series.

This scale has been designed with TEC reliability and offers a cost efficient system for a modest investment.

The SL-5900 (with thermal printer) takes advantage of the latest technology in microprocessors and because of this, the decreased cabinet size permits the system to be placed virtually anywhere in your store.

Your deli, and specialty departments can enjoy these high quality reliable TEC products. Improve your operating effectiveness and watch the enhanced utilization of your front end scanning investment. This electronic Load Cell scale eliminates all moving parts and furnishes an accurate digital display of all information.

We believe that your needs will now be fully satisfied, and you will have total reliability in price calculation. Should you have any questions concerning the scale, please refer to this manual. Be sure to keep this manual for future reference.

This equipment has been tested and found to comply with the limits for a Class A digital device, pursuant to Part 15 of the FCC Rules. These limits are designed to provide reasonable protection against harmful interference when the equipment is operated in a commercial environment. This equipment generates, uses, and can radiate radio frequency energy and, if not installed and used in accordance with the instruction manual, may cause harmful interference to radio communications. Operations of this equipment in a residential area is likely to cause harmful interference in which case the user will be required to correct the interference at his own expense. (for USA only)

Changes or modifications not expressly approved by manufacturer for compliance could void the user's authority to operate the equipment.

"This Class A digital apparatus meets all requirements of the Canadian Interference-Causing Equipment Regulations."

"Cet appareil numérique de la classe A respecte toutes les exigences du Règlement sur le matériel brouilleur du Canada."

(for CANADA only)

Safety Summary

Personal safety in handling or maintaining the equipment is extremely important. Warnings and Cautions necessary for safe handling are included in this manual. All warnings and cautions contained in this manual should be read and understood before handling or maintaining the equipment.

Do not attempt to effect repairs to this equipment. If a fault occurs that cannot be rectified using the procedures described in this manual, turn off the power, unplug the machine, then contact your authorised TEC representative for assistance.

Safety Precautions

This Owner's Manual and the products (machines) which you have purchased contain indications which should be observed in order to use the machines safely and prevent harm to yourself and others and damage to property. The meanings of these indications and symbols are given below. Read these indications and become familiar with their contents before reading this Owner's Manual.

The following safety precaution will help to ensure proper use of the scale.

- Unplug the printer whenever you are working inside the scale.
- Keep your work environment static free.

Meanings of Each Symbol



This symbol indicates warning items (including cautions). Specific warning contents are drawn inside the Δ symbol. (The symbol on the left indicates a general caution.)



This symbol indicates prohibited actions (prohibited items). Specific prohibited contents are drawn inside or near the \odot symbol. (The symbol on the left indicates "no disassembling".)



This symbol indicates actions which must be performed. Specific instructions are drawn inside or near the \bullet symbol. (The symbol on the left indicates "disconnect the power cord plug from the outlet".)



WARNING

This indicates that there is the risk of **death** or **serious injury** if the machines are **improperly** handled contrary to this indication.



Prohibited

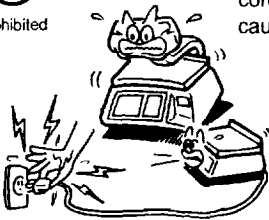

■ Do not plug in or unplug the power cord plug with wet hands as this may cause **electric shock**.



Any other than the specified AC voltage is prohibited.

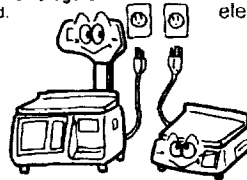

■ Do not use voltages other than the voltage (AC) specified on the rating plate, as this may cause fire or electric shock.



Prohibited

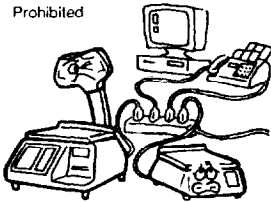

■ If the machines share the same outlet with any other electrical appliances which consume large amounts of power, the voltage will fluctuate widely each time these appliances operate. Be sure to provide an exclusive outlet for the machine as this may cause the machines to **malfunction**.



Prohibited

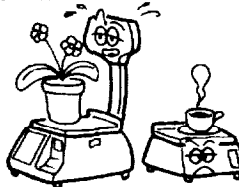

■ Do not place metal objects or water-filled containers such as flower vases, flower pots or mugs, etc. on top of the machines. If metal objects or spilled liquid enter the machines, this may cause **fire** or **electric shock**.



Prohibited

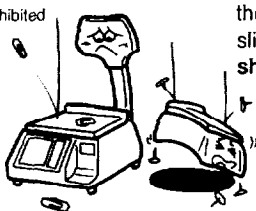







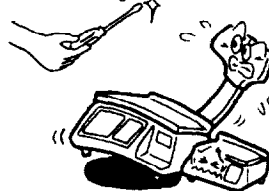





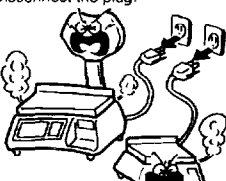



■ Do not insert or drop metal, flammable or other foreign objects into the machines through the ventilation slits, as this may cause **fire** or **electric shock**.

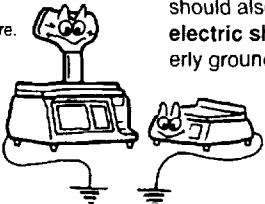

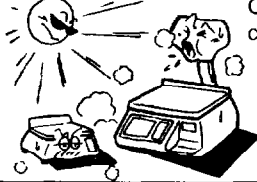

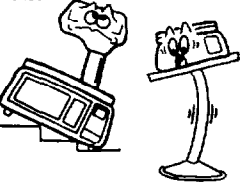

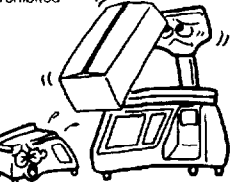

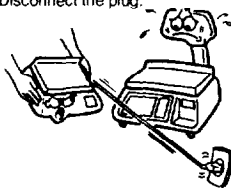

No disassembling.

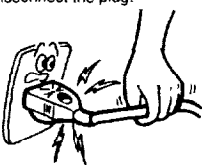

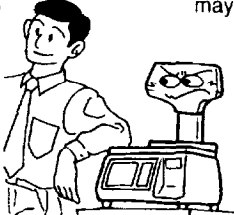
■ Do not remove covers, repair or modify the machine by yourself. You may be **injured** by high voltage, very hot parts or sharp edges inside the machine.

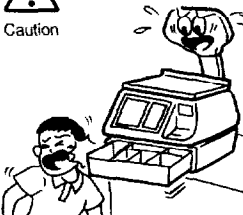
 <p>Prohibited</p>  <p>■ Do not scratch, damage or modify the power cords. Also, do not place heavy objects on, pull on, or excessively bend the cords, as this may cause fire or electric shock.</p>	 <p>Disconnect the plug.</p>  <p>■ Continued use of the machines in an abnormal condition such as when the machines are producing smoke or strange smells may cause fire or electric shock. In these cases, immediately turn off the power switches and disconnect the power cord plugs from the outlet. Then, contact your sales agent (or maintenance and service agent).</p>
 <p>Disconnect the plug.</p>  <p>■ If foreign objects (metal fragments, water, liquids) enter the machines, first turn off the power switches and disconnect the power cord plugs from the outlet, and the contact your sales agent (or maintenance and service agent). Continued use of the machine in that condition may cause fire or electric shock.</p>	 <p>Disconnect the plug.</p>  <p>■ If the machines are dropped or their cabinets damaged, first turn off the power switches and disconnect the power cord plugs from the outlet, and the contact your sales agent (or maintenance and service agent). Continued use of the machine in that condition may cause fire or electric shock.</p>
 <p>Connect a grounding wire.</p>  <p>■ Ensure that the equipment is properly grounded. Extension cables should also be grounded. Fire or electric shock can occur on improperly grounded equipment.</p>	
 <h2 style="display: inline;">CAUTION</h2> <p>This indicates that there is the risk of personal Injury or damage to objects if the machines are improperly handled contrary to this indication.</p>	
 <p>Prohibited</p>  <p>■ Do not install the machines where they might be exposed to direct sunlight, high humidity, or dust. Otherwise fire or electric shock could occur.</p>	 <p>Prohibited</p> <p>[Precautions During installation]</p> <p>■ Do not place the machines on unstable or slanted surfaces, as they may drop or fall and cause injury.</p> 
 <p>Prohibited</p>  <p>■ Do not place heavy objects on top of the machines, as these items may become unbalanced and fall causing injury.</p>	 <p>Prohibited</p> <p>■ Do not block the ventilation slits of the machines, as this will cause heat to build up inside the machines and may cause fire.</p> 

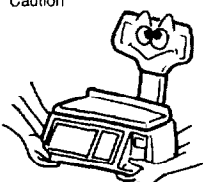
 <p>Disconnect the plug.</p>  <p>[Precautions When Moving the Machines]</p> <p>■ When moving the machines, be sure to first unplug the power cords. Moving the machines with the power cords plugged in may damage the cords and cause fire or electric shock.</p>	 <p>Disconnect the plug.</p>  <p>■ When unplugging the power cords, be sure to hold and pull on the plug portion. Pulling on the cord portion may cut or expose the internal wires and cause fire or electric shock.</p>
 <p>Caution</p>  <p>■ Do not lean against the machine. It may fall and be damaged.</p>	 <p>Caution</p>  <p>■ When opening the cash drawer, be careful not to let the drawer hit children's heads, etc., as this may cause injury.</p>
 <p>Caution</p>  <p>■ Be sure to move large scale machines with two or more people. In addition, machines should be moved after first confirming that connecting wires between machines and externally connected wires, etc. have been removed. Failure to observe these precautions may result in injury.</p>	
<p>Precaution</p> <p>The following precautions will help to ensure that this machine will continue to function correctly.</p> <ol style="list-style-type: none"> ① Try to avoid locations that have the following adverse conditions: <ul style="list-style-type: none"> * Temperatures below 0°C and above 40°C * Direct sunlight * Shared power socket * Excessive vibration ② Do not subject the weighing platter to sudden shocks. ③ Do not press the keys too hard. Keys will operate correctly if they are touched lightly. ④ Clean the cover and weighing platter by wiping with a dry cloth or a cloth soaked with detergent and wrung out thoroughly. Never use thinner or other volatile solvent for cleaning. ⑤ To ensure that the scale is operating correctly, place a known weight on the platter and check it for correct weight measurement. This should be done every morning before starting normal operations. ⑥ At the end of the day, turn the power OFF, then clean and inspect the exterior of the scale. ⑦ Try to avoid using this equipment on the same power supply as high voltage equipment or equipment likely to cause mains interference (freezer cabinets etc.). ⑧ <u>USE ONLY TEC SPECIFIED</u> media. ⑨ DO NOT STORE the media where they might be exposed to direct sunlight, high temperatures, high humidity, dust, or gas. ⑩ When moving the scale, take hold of the case and lift the scale. Never hold the remote unit. 	

1. SPECIFICATIONS

Item	30-C2	35-C2	35-C4	36-C4
Maximum Capacity	30 lbs.			
Minimum Scale Division	0.01 lb.			
Display Range	0~30.05 lbs.			
Tare	Up to 30 lbs.			
Unit Price Presetable	\$0.01~99.99			
Minimum Price Display	\$0.01			
Remote Display :				
Weight	4 digits			
Unit Price	4 digits			
Total Price	5 digits			
Message Display (option)	16 characters (5x7 dot matrix)			
Display Designations	NET, PREPACK, INLINE, ERROR, ACCM, ITEMS			
Remote Display Mode	Dual sides			
Capacity of PLU Memory	400 PLUs (standard), 1240 PLUs max. (option)			
Print Head	Thermal Print Head			
Label Issue Method	On-demand			
Available Printing Width	1.65"			
Label	RICOH 120LA or equivalent			
Report Paper	RICOH 115F (black) or equivalent			
Power Requirement	AC 120V ± 10%, 60Hz			
Current Consumption	120V·1A, 60Hz			
Temperature Limits	0°C ~ +40°C (32°F ~ 104°F)			
Relative Humidity	35% ~ 85% RH (No condensation)			
Dimensions (approx.)	15.7" (W) x 16.2" (D) x 18.7" (H)			
Weight (approx.)	29 lbs.			
Memory Card	MC-128KB			
Interface :				
CMT Loader I/F	Standard	Standard	Standard	Standard
FUN System I/F	Standard	Standard	Standard	Standard
PC Keyboard I/F	Standard	Standard	Standard	Standard
TMCC I/F	_____	Standard	Standard	Standard
Memory Card I/F	_____	_____	_____	Standard

■ Option Kit and Device

Cassette Magnetice Tape Loader :	AIWA DR-1
PC Keyboard (for programming) :	IBM PC-XT Keyboard, FUJITSU FKB-2831-001, FUJITSU FKB-2831-101 For use of other keyboards, please contact your TEC representative.
Programming Keyboard :	TEC RK-3
Programming Keyboard Adapter :	TEC OP-57-RK-3
Message Display Kit :	OP-LCDFIU-US (Except SL-5900-35-C4-US)
TMCC Cable Kit :	OP-5900-TMCC

■ FUN System

The SL-5900 is based on the FUN (File Update Network) system, which is a simplified networking system unique to TEC. This system can accommodate up to 16 terminals as a multi-drop, and allows any terminal in the system to transfer its PLU file or UNIT PRICE data to other terminals for verification.

■ System Configuration

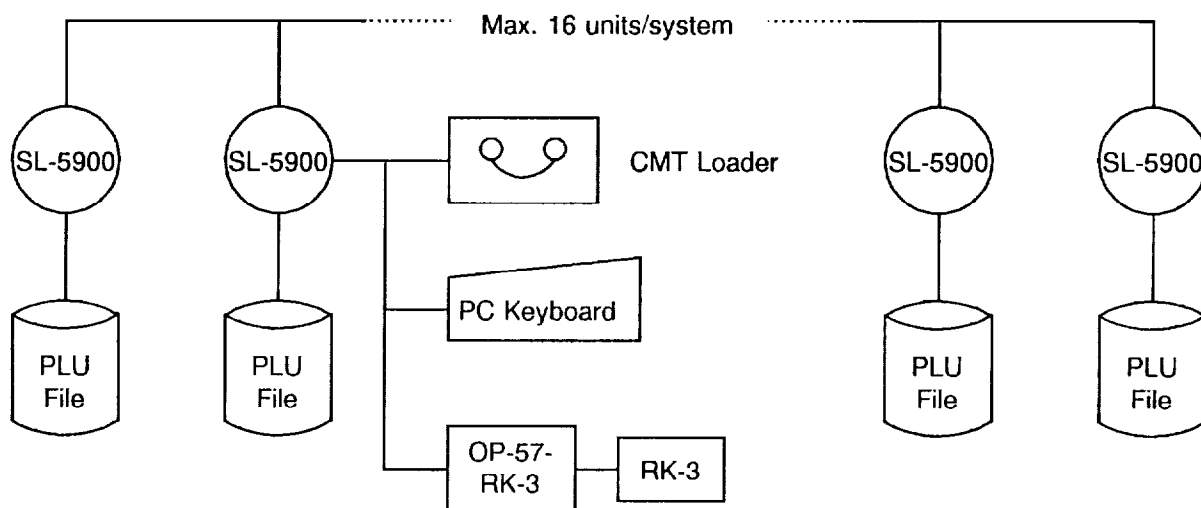

Control Procedure : FUN (File Update Network) ... Multi-drop
 Transmission Speed : 4800 BPS
 Number of unit/system : Max. 16 units

2. OVERVIEW

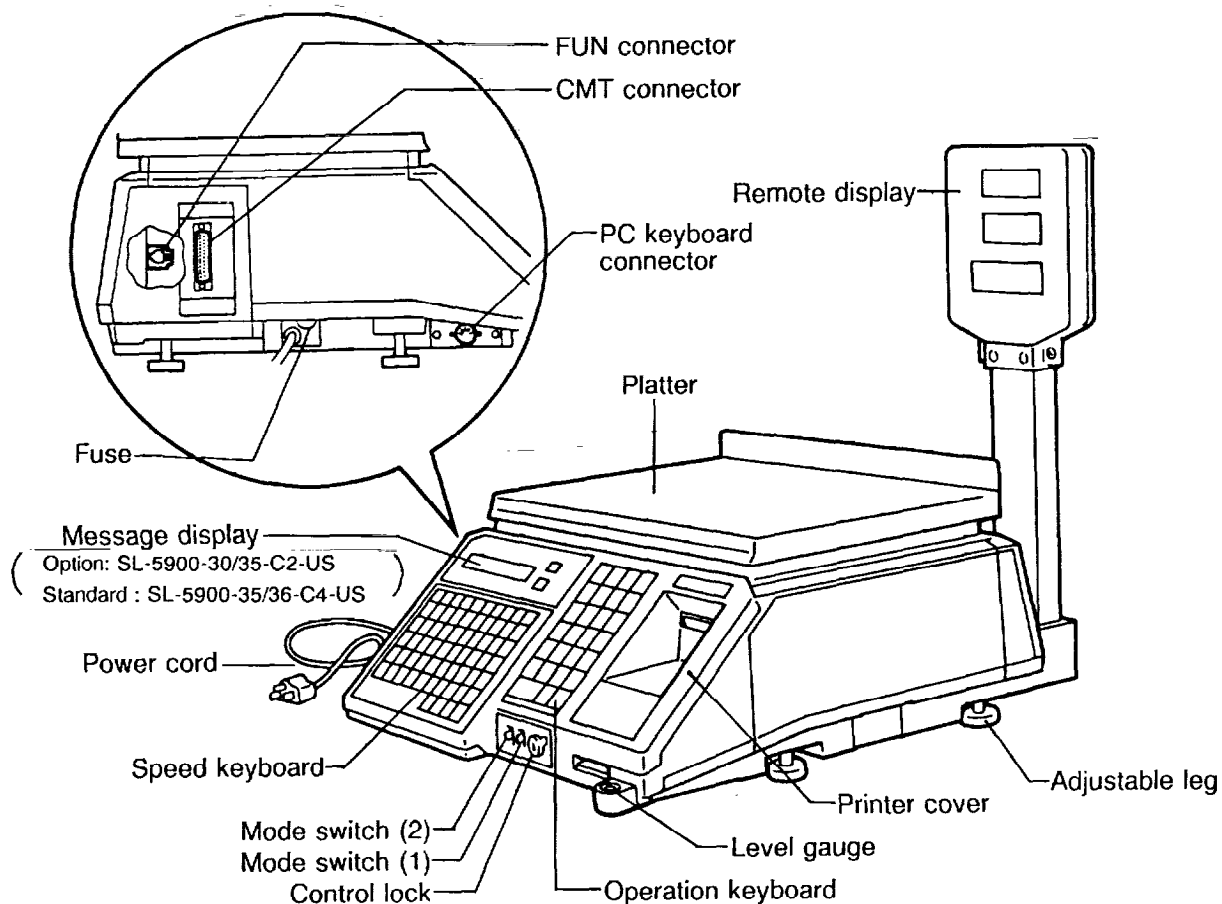

3. REMOTE DISPLAY

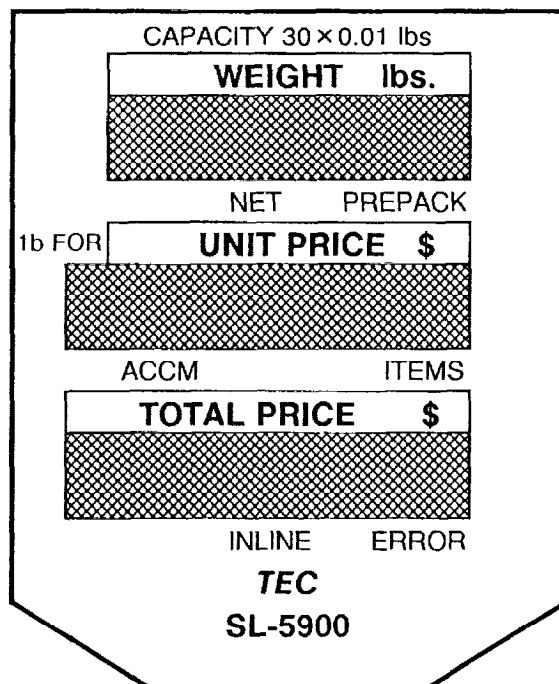

4. KEY LAYOUT

■ Operation Keyboard

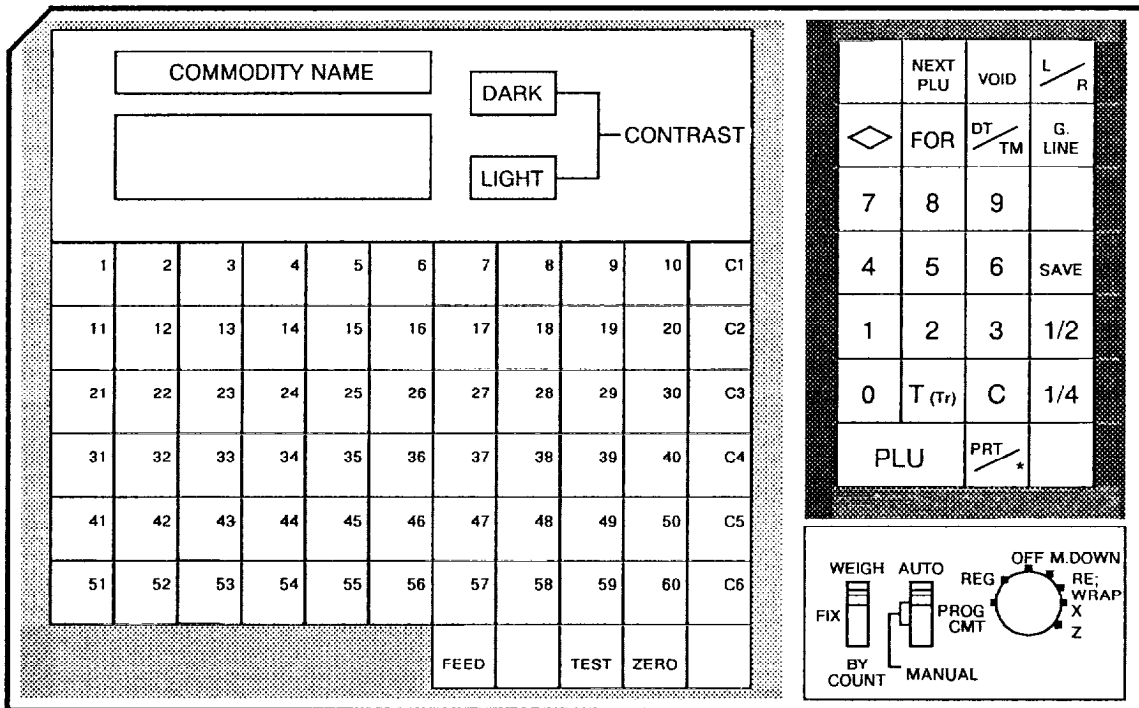

NOTE : The characters (1~60) indicated on the speed keys are shown for the convenience of explanation in this manual. The indications on the actual unit are not as shown in this illustration.

■ Programming Keyboard

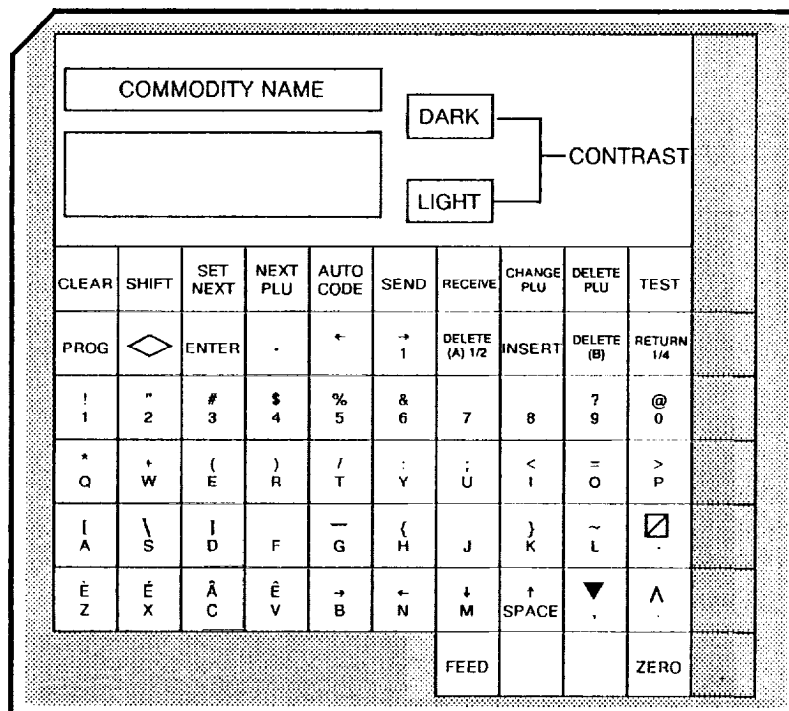

■ PC Keyboard (for programming)

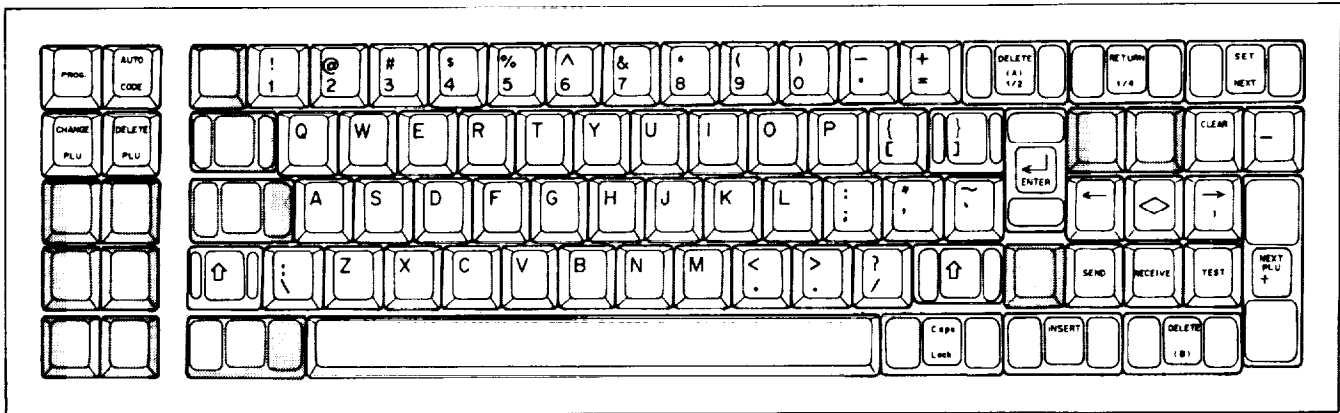



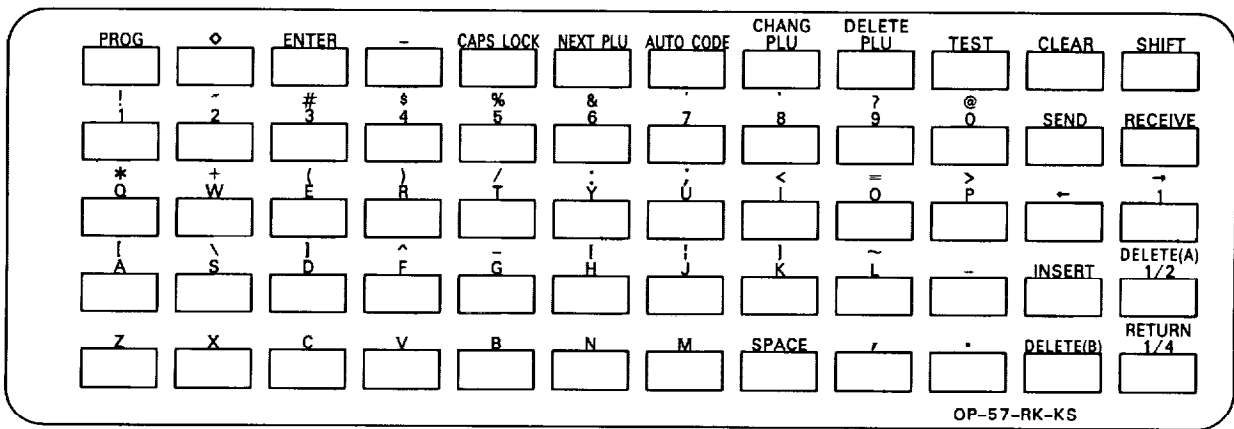







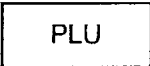

■ RK-3 (with OP-57-RK-KS) Keyboard (for programming)

















5. KEY FUNCTIONS

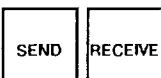





■ For Operation Keyboard

Switch & Key	Function
Mode Switch (1) 	<p>“AUTO” position: This position is used to issue regular scale labels. When the weight becomes stable, the label will automatically be issued.</p> <p>“MANUAL” position: When the weight becomes stable, the label will be issued by depressing the PRINT key.</p>
Mode Switch (2) 	<p>“WEIGH” position: This position is used in the weighing function of the SL-5900.</p> <p>“FIX” position: The unit price is entered directly to the total price on calling up PLU, and that total price cannot be changed by any subsequent weighing.</p> <p>“BY COUNT” position: It is available to produce labels which contain information on quantity pricing, instead of weight.</p>
CLEAR Key 	This key is used for clear-entry of numeric keys. It is also used to release the scale from the save mode and/or error mode.
DATE & TIME Key 	This key is used to indicate the date on a remote display and for temporary date changes.
FEED Key 	This key is used to feed labels or report paper.
FOR Key 	In the “X” or “Z” control lock position, this key is used to generate the zone total report.
NEXT PLU Key 	This key is used to call out the next PLU #, and forward the operation step to the next step.
NUMERIC Keys 	These keys are used to enter numeric data (PLU#, unit price, tare weight, etc.).
Per 1/2 Key 	This key is used to calculate the unit price by 1/2 lbs.

Switch & Key	Function
Per 1/4 Key 	This key is used to calculate the unit price by 1/4 lbs.
PLU Key 	This key is used to select a PLU number or return to the initial mode.
PRINT Key 	If the Mode Switch (1) is set to the MANUAL position, it has the function of label issue. This key is used for issuing total labels.
SAVE Key 	This key is used to save tare and unit price after removing the commodity from the platter.
SPEED Keys 	These keys are used to set and call the PLU data of frequently used commodities.
TARE Key 	This key is used to subtract tare weight.
TEST Key 	This key is used to issue test labels.
VOID Key 	This key is used to cancel only one commodity's data by depressing this key after its registration.
ZERO Key 	This key is used to adjust the "ZERO" point.
	This key is used to subtract an item which was entered previously in the sale or to cancel all the items entered in the sale. In the "X" or "Z" control lock position, this key is used to generate the block total report.
GRADE LINE key 	This key is used to call the Grade Line message.
LABEL & REPORT PAPER key 	This key is used to select label printout or report paper printout.
CLERK keys 	These keys are used for entry operation by clerk and add entry operation by clerk.







■ For Programming Keyboards

Key	Function	SL-5900	PC Key	RK-3
	This key allows the clearing of numeric entries prior to the depression of another function key. It is also used to release the scale from the error mode.	<input type="radio"/>	<input type="radio"/>	<input type="radio"/>
	This key is used to select the upper or lower character indicated on the keytop when setting the commodity name or store address.	<input type="radio"/>	<input checked="" type="radio"/>	<input type="radio"/>
	While this key is pressed down, press a character key to set the small letter of alphabet, or upper-case character indicated on the upper area of the keytop. When this key is released, the shifted status is cancelled.	<input checked="" type="radio"/>	<input type="radio"/>	<input checked="" type="radio"/>
	This key is used to recall the next PLU # (+ 1) of the PLU # currently recalled.	<input type="radio"/>	<input type="radio"/>	<input checked="" type="radio"/>
	This key is used to recall the PLU # which is registered next to the current recalled PLU #. It is also used to skip the digit when setting the bar code format.	<input type="radio"/>	<input type="radio"/>	<input type="radio"/>
	This key is used to set the auto code for UPC #.	<input type="radio"/>	<input type="radio"/>	<input type="radio"/>
	These keys are not used. (No function)	<input type="radio"/>	<input type="radio"/>	<input type="radio"/>
	This key is used to change the PLU # currently recalled.	<input type="radio"/>	<input type="radio"/>	<input type="radio"/>
	When a PLU is no longer to be maintained in the PLU file, this key is used to delete such PLU data.	<input type="radio"/>	<input type="radio"/>	<input type="radio"/>
	This key is used to print out the data set in the currently recalled PLU.	<input type="radio"/>	<input type="radio"/>	<input type="radio"/>
	This key is used to access each programming menu.	<input type="radio"/>	<input type="radio"/>	<input type="radio"/>
	This key is used to select selectable items.	<input type="radio"/>	<input type="radio"/>	<input type="radio"/>
	During programming, data is input to the SL-5900 system using this key.	<input type="radio"/>	<input type="radio"/>	<input type="radio"/>
	This key is used to set the free zone of the auto code for UPC #, back the digit when setting the bar code format, and return the setting line to the first line while setting the second line and during the setting of the commodity name or store address.	<input type="radio"/>	<input type="radio"/>	<input type="radio"/>

Key	Function	SL-5900	PC Key	RK-3
	This key is used to back the digit when setting the commodity name or store address.	<input type="radio"/>	<input type="radio"/>	<input type="radio"/>
	This key is used to skip the digit when setting the commodity name or store address.	<input type="radio"/>	<input type="radio"/>	<input type="radio"/>
	This key is used to delete a character when setting the commodity name or store address. When setting the unit price for the weighed PLU, this key is used to set the unit price to the price per 1/2 lbs.	<input type="radio"/>	<input type="radio"/>	<input type="radio"/>
	This key is used to insert a space at the digit when setting the commodity name or store address.	<input type="radio"/>	<input type="radio"/>	<input type="radio"/>
	This key is used to clear all characters on the current setting line when setting the commodity name or store address.	<input type="radio"/>	<input type="radio"/>	<input type="radio"/>
	This key is used to move the setting line when setting the commodity name or store address. When setting the unit price for the weighed PLU, this key is used to set the unit price to the unit price per 1/4 lbs.	<input type="radio"/>	<input type="radio"/>	<input type="radio"/>
	Press this key to lock the keyboard into the shifted status. While this key is pressed down, press a character key to set the small letter of alphabet. When this key is released, the shifted status is cancelled.	<input checked="" type="radio"/>	<input type="radio"/>	<input type="radio"/>

NOTE : When the power is turned off or control lock is switched, the PC keyboard or RK-3 keyboard will be initialized to select capital letters.

6. LAMP FUNCTIONS

Lamp	Function
NET 	Lights when tare is subtracted.
PREPACK 	Lights when the SAVE key is pressed.
INLINE 	Lights when the PLU or unit price file is updated. Lights when the scale (for SL-5900-35/36) is in the IN-LINE mode.
ERROR 	Lights when the scale is improperly operated or there is a function error.
ACCM 	This lamp lights when items are being added to the specific CLERK memory in the add entry by clerk mode (for SL-5900-36).
ITEMS 	This lamp lights when items are being added to any CLERK memory in the sub-total operation in the add entry by clerk mode (for SL-5900-36).

7. CONTROL LOCK

The control lock has seven marked positions.

There are two control keys which will operate these locks.



- **Manager Key**
This key (MA) will access the PROG/CMT, REG, OFF, M. DOWN, and REWRAP positions.



- **SE Key**
This key (SE) will access all seven positions.

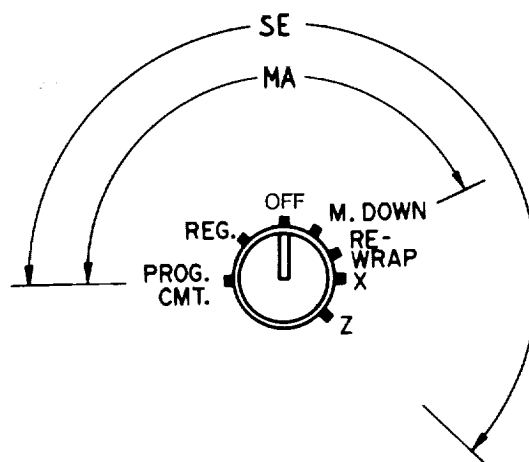

Each of the following positions on the control lock serves a different function.

Position	Function
PROG. CMT.	This position is used to set the data of the PLU, store address, printing position, date, time, bar code format, etc. It is also used to transfer the PLU file using a CMT loader.
REG.	This position is the normal control lock position which allow the issuance of printed labels.
OFF	This position is used to lock the scale power.
M. DOWN	This position is used to designate an item for discount pricing.
REWRAP	This position is used to designate an item for rewrapping products.
X (Read)	This position is used to read all the accumulated sales totals stored in the total memory.
Z (Reset)	This position is used to reset all item file totals.

8. LEVEL ADJUSTMENT

Set the scale on a stable and level surface. Level the scale by turning the adjustable legs so that the air bubble is inside the center circle.

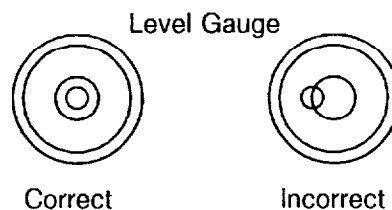

When the air bubble moves toward the left side, turn the right adjustable legs clockwise.

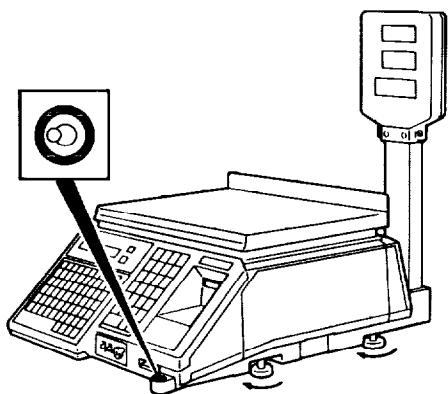

When the air bubble moves toward rear, turn the front adjustable legs clockwise.

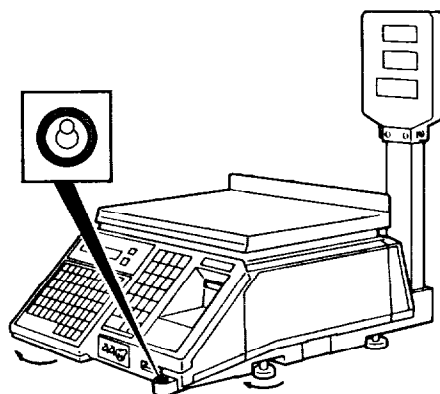

9. CLEANING THE PRINT HEAD

If the print head is dirty, clear printing will not be produced. It is recommended to clean the head with thermal head cleaner everyday before starting operation using the following procedure:

1. Remove the printer cover and label cassette. Then push the head-up lever in the direction indicated by the arrow.

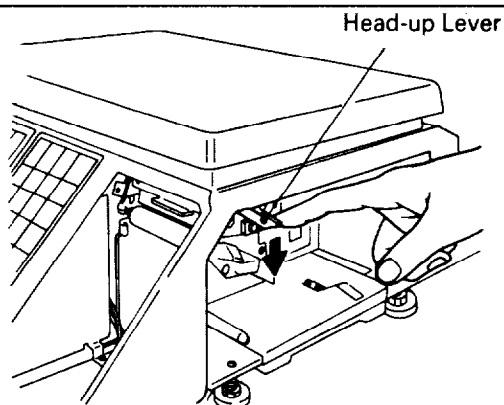

2. Wipe off the dirt on the blackened portion in the figure to the right with the thermal head cleaner. Then set the label cassette, and push down the print head.

NOTE: Be careful not to damage the print head when cleaning.

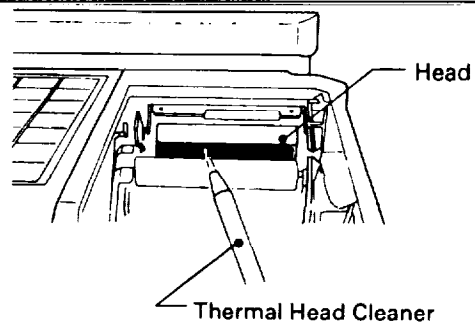

10. REMOVAL AND REPLACEMENT OF LABEL ROLL

1. Remove the printer cover and right side cover. Then push the head-up lever in the direction indicated by the allow.

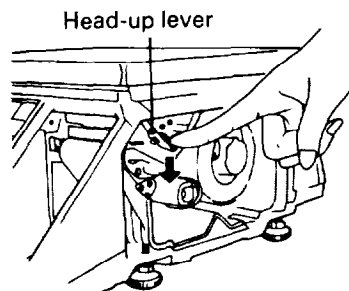

2. Pull out the label cassette. Then remove the core of the label roll and the label backing paper.

NOTE: To remove the label backing paper, loosen the paper by turning the paper winding shaft counterclockwise and remove the paper stopper.

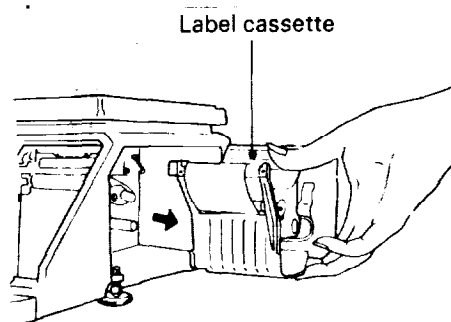

3. Referring to the figure on the right, set the label roll on the label cassette.

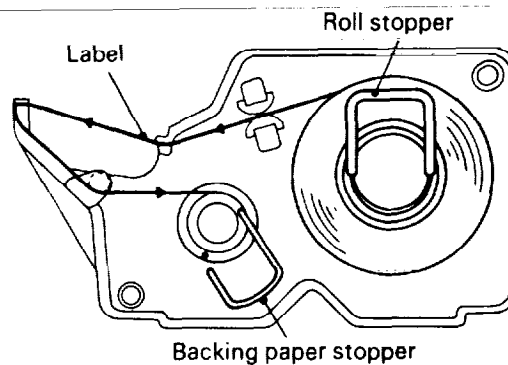

4. Set the label cassette.

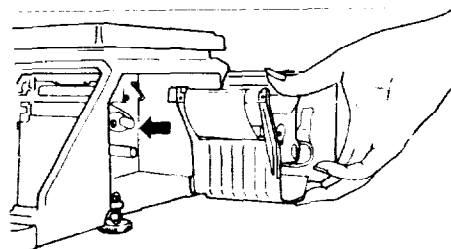

5. Push down the print head, and close the covers.

NOTE: When the label roll is replaced, press the feed key to confirm that the label is issued correctly.

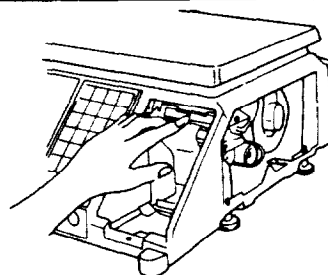

11. REPORT PAPER THREADING

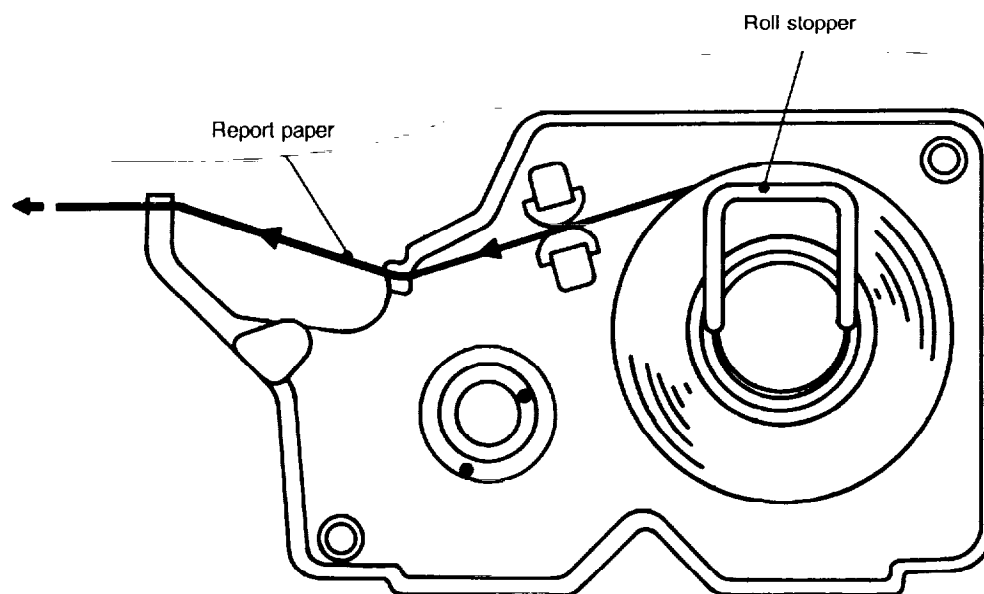

12. BEFORE STARTING OPERATION

- (1) Be sure to plug the power plug into an AC outlet.
- (2) When the control lock is turned from OFF to REG position, the scale goes through the test scanning sequence, such as 0000, 0000, 00000, then 1111, 1111, 11111 and zeros appear on the weight and total price displays. When the control lock is turned from OFF to REG over 16 seconds after the power plug is plugged into an AC outlet, all "8"s appear on all displays for a moment, then zeros appear on the displays and the scale is ready for use.
- (3) While the scale is in the test sequence, do not put anything on the platter.
- (4) Do not move the scale while it is in operation. Should it become necessary to move it at any time, turn the power OFF and be sure to readjust the level indicator after relocating the scale.
- (5) Should a power failure occur during operation, remove the commodity from the platter and plug the power plug into an AC outlet again when power is restored.
- (6) If the scale is used with an unrated power source, inaccurate scaling or other errors may occur.
- (7) If the Zero Point has shifted during scaling, and no tare is displayed, adjust the Zero Point by depressing the ZERO key.

13. OPERATING PROCEDURES

13.1 WEIGHED COMMODITY REGISTRATION

Control lock : REG, M.DOWN, or REWRAP
 Mode SW (2) : WEIGH

[Example A] In the event that an unit price of \$3.00 is set for PLU#100.

Step No.	Procedure	WEIGHT	UNIT PRICE	TOTAL PRICE	NET	P	I	E	A	I
1	Enter the PLU# . 1 0 0	0.00	P	000100						
2	Depress the PLU key.	0.00	3.00	0.00						
3	Place a commodity on the platter. (ex. 2 lbs.)	2.00	3.00	6.00						
4	Mode SW (1) : AUTO The label is issued automatically. Mode SW (1) : MANUAL The label is issued after depressing the PRINT key.	<div style="border: 1px solid black; padding: 5px;"> <p>T-BONE STEAK</p>  <p>PACKED ON DEC 1 SELL BY DEC 6</p> <p>2.00 3.00 \$6.00</p> <p>NET WT. (LBS) PRICE/LB \$ TOTAL PRICE \$</p> <p>19250 VAN NESS AVE. TEL 213(320)8900</p> </div>								
5	Remove the commodity from the platter. PLU data is returned to the PLU file.	0.00	P	000000						

NOTE : Recalling a PLU# that has not been set in the PLU file will result in an error. In this case, depress the CLEAR key, then enter a correct PLU#.

[Example B] In the event that PLU#100 and an unit price of \$3.00 are set in the speed key #1.

Step No.	Procedure	WEIGHT	UNIT PRICE	TOTAL PRICE	NET WT	P REF PACK	I N L I N E	E R R O R	A C C M	I T E M S
1	Depress the speed key #1.	0.00	3.00	0.00						
2	Place a commodity on the platter. (ex. 2 lbs.)	2.00	3.00	6.00						
3	SW (1) : AUTO The label is issued automatically. Mode SW (1) : MANUAL The label is issued after depressing the PRINT key.									
4	Remove the commodity from the platter. PLU data is returned to the speed key and PLU file.	0.00	P	000000						

NOTE : Depressing a speed key to which no PLU data has been assigned will result in an error. In this case, depress the CLEAR key, then depress a speed key to which PLU data has been assigned.

[Example C] In the event that an open unit price is set for PLU#103.

Step No.	Procedure	WEIGHT	UNIT PRICE	TOTAL PRICE	NET WT	P REF PACK	I N L I N E	E R R O R	A C C M	I T E M S
1	Enter the PLU# . 1 0 3	0.00	P	000103						
2	Depress the PLU key.	0.00	0.00	0.00						
3	Enter the unit price. (ex. \$1.25)	0.00	1.25	0.00						
4	Place a commodity on the platter. (ex. 2 lbs.)	2.00	1.25	2.50						
5	Mode SW (1) : AUTO The label is issued automatically. Mode SW (1) : MANUAL The label is issued after depressing the PRINT key.									

[Example D] In the event that an unit price is \$1.50 **Random Item PLU**
 (optional function by initial setting)

Step No.	Procedure	WEIGHT	UNIT PRICE	TOTAL PRICE	NET	KC>PRP	PLZ-LZ	FFROR	ACC	ITEMS
1	Depress the PLU key.	0.00	0.00	0.00						
2	Enter the unit price. (ex. \$1.50)	0.00	1.50	0.00						
3	Place a commodity on the platter. (ex. 3 lbs.)	3.00	1.50	4.50						
4	Mode SW (1) : AUTO The label is issued automatically. Mode SW (1) : MANUAL The label is issued after depressing the PRINT key.									

NOTES :

1. This operation is available only when the Random Item PLU is set to "Available" in initial setting.
2. Although the Random Item PLU is handled as PLU#0 in the REG mode, it is handled as PLU# 999999 in the PLU file.

13.2 FIX PRICE REGISTRATION

Control lock : REG, M.DOWN, or REWRAP

Mode SW (2) : FIX

[Example A] In the event that an unit price of \$1.25 is set for PLU#33.

Step No.	Procedure	WEIGHT	UNIT PRICE	TOTAL PRICE	NET	PREPACK	IN LINE	ERROR	ACCM	ITEMS
1	Enter the PLU#. 3 3	0.00	P	000033						
2	Depress the PLU key.	0.00		1.25						
3	Place a commodity on the platter. (ex. 1 lb.)	1.00		1.25						
4	Mode SW (1) : AUTO The label is issued automatically. Mode SW (1) : MANUAL The label is issued after depressing the PRINT key.	<p style="text-align: center;">CREAM CAKE</p> <p style="text-align: center;">PACKED ON DEC 1 SELL BY DEC 4</p> <p style="text-align: center;">1.00 \$1.25</p> <p style="text-align: center;">NET WT. <small>lbs</small> PRICE/lb <small>lbs</small> TOTAL PRICE <small>\$</small></p> <p style="text-align: center;">19250 VAN NESS AVE. TEL 213(320)8900</p>								

[Example B] In the event that an open unit price is set for PLU#32.

Step No.	Procedure	WEIGHT	UNIT PRICE	TOTAL PRICE	NET	PREPACK	IN LINE	ERROR	ACCM	ITEMS
1	Enter the PLU#. 3 2	0.00	P	000032						
2	Depress the PLU key.	0.00		0.00						
3	Enter the price. (ex. \$2.00)	0.00		2.00						
4	Place a commodity on the platter. (ex. 1 lb.)	1.00		2.00						
5	Mode SW (1) : AUTO The label is issued automatically. Mode SW (1) : MANUAL The label is issued after depressing the PRINT key.	<p style="text-align: center;">CHOCOLATE MERINGUE PIE</p> <p style="text-align: center;">PACKED ON DEC 1 SELL BY DEC 5</p> <p style="text-align: center;">1.00 \$2.00</p> <p style="text-align: center;">NET WT. <small>lbs</small> PRICE/lb <small>lbs</small> TOTAL PRICE <small>\$</small></p> <p style="text-align: center;">19250 VAN NESS AVE. TEL 213(320)8900</p>								

13.3 BY COUNT REGISTRATION (standard function)

Control lock : REG, M.DOWN, or REWRAP

Mode SW (2) : BY COUNT

[Example A] In the event that PLU#302 and a price of \$3.00 per 6 pieces are set in the speed key #21.

Step No.	Procedure	WEIGHT	UNIT PRICE	TOTAL PRICE	NET	P P R E P A C K	I N L I N E	E R R O R	A C C M	I T E M S
1	Enter the speed key #21.	----	P 6	3.00						
2	Depress the PRINT key.									
3	Mode SW (1) : AUTO Labels are issued in succession after they are peeled. Mode SW (1) : MANUAL Single label is issued.									

NOTE : When Mode SW (1) is in the "AUTO" position, the desired number of identical labels can be obtained by just depressing the PRINT key to issue the first label, then a next label will be issued once after peeling it until depressing the CLEAR key.

[Example B] In the event that a price of \$2.50 per 12 pieces is set for PLU#303.

Step No.	Procedure	WEIGHT	UNIT PRICE	TOTAL PRICE	NET	P P R E P A C K	I N L I N E	E R R O R	A C C M	I T E M S
1	Enter the PLU#. 3 0 3	----	P	000303						
2	Depress the PLU key.	----	P 12	2.50						
3	Depress the PRINT key.									
4	Mode SW (1) : AUTO Labels are issued in succession after they are peeled. Mode SW (1) : MANUAL Single label is issued.									

[Example C] In case of purchasing 10 pieces of commodity at a price of \$1.00 per 6 pieces
 SPLIT PRICE
 (In the event that a price of \$1.00 per 6 pieces is set for PLU#39.)

Step No.	Procedure	WEIGHT	UNIT PRICE	TOTAL PRICE	NET	PREPACK	IN LINE	ERROR	ACCM	ITEMS
1	Enter the PLU #.	---	P	000039						
2	Depress the PLU key.	---	P 6	1.00						
3	Enter the quantity of purchase. (ex. 10 pieces) ... max. 2 digits	---	10	1.00						
4	Depress the PRINT key.	---	P 10	1.68						
5	Mode SW (1) : AUTO Labels are issued in succession after they are peeled. Mode SW (1) : MANUAL Single label is issued.	<div style="border: 1px solid black; padding: 5px;"> <p style="text-align: center;">DONUTS</p>  <p style="text-align: right;">PACKED ON DEC 1 SELL BY DEC 4</p> <p style="text-align: center;">10 PIECES \$1.68</p> <p style="font-size: small;">NET WT. (G) PRICE/6G TOTAL PRICE (\$)</p> <p style="font-size: x-small;">19250 VAN NESS AVE. TEL 213(320)8900</p> </div>								

13.4 BY COUNT REGISTRATION (optional function by initial setting)

Control lock : REG, M.DOWN, or REWRAP

Mode SW (2) : BY COUNT

[Example A] In the event that an unit price of \$1.75 is set for PLU#31.

Step No.	Procedure	WEIGHT	UNIT PRICE	TOTAL PRICE	NET	PREPACK	IN LINE	ERROR	ACCM	ITEMS
1	Enter the PLU #.	---	P	000031						
2	Depress the PLU key.	---	1.75	0.00						
3	Enter the quantity of purchase. (ex. 2 pieces)	---	2	1.75						
4	Depress the FOR key.	---	P 2	1.75						
5	Depress the PRINT key.	<div style="border: 1px solid black; padding: 5px;"> <p style="text-align: center;">BLUEBERRY PIE</p>  <p style="text-align: right;">PACKED ON DEC 1 SELL BY DEC 5</p> <p style="text-align: center;">2 PIECES \$1.75</p> <p>NET WT. 1.5 PRICE/1b 1.75 TOTAL PRICE 2.63</p> <p>19250 VAN NESS AVE. TEL 213(320)8900</p> </div>								
6	Mode SW (1) : AUTO Labels are issued in succession after they are peeled. Mode SW (1) : MANUAL Single label is issued.									

[Example B] In case of purchasing 6 pieces of commodity at a price of \$2.75 per 3 pieces
 **SPLIT PRICE**
 (In the event that PLU#826 and a price of \$2.75 are set in the speed key #40.)

Step No.	Procedure	WEIGHT	UNIT PRICE	TOTAL PRICE	NET	BACK	LINE	ERROR	ACCM	ITEMS
1	Depress the speed key #40.	---.---	2.75	0.00						
2	Enter the quantity of purchase. (ex. 6 pieces)	---.---	6	2.75						
3	Depress the FOR key.	---.---	P 6	2.75						
4	Enter the quantity for that price.	---.---	3	2.75						
5	Depress the FOR key.	---.---	P 3	2.75						
6	Depress the PRINT key.	---.---	P 6	5.50						
7	Mode SW (1) : AUTO Labels are issued in succession after they are peeled. Mode SW (1) : MANUAL Single label is issued.	<div style="border: 1px solid black; padding: 5px;"> <p style="text-align: center;">LARGE SHRIMPS</p>  <p style="text-align: right;">PACKED ON DEC 1 SELL BY DEC 5</p> <p style="text-align: center;">6 PIECES \$5.50</p> <p>NET WT. 0.5 PRICE/lb 11.00 TOTAL PRICE 5.50</p> <p>19250 VAN NESS AVE. TEL 213(320)8900</p> </div>								

13.5 TARE FUNCTION PROCEDURES

Control lock : REG, M.DOWN, or REWRAP

Mode SW (2) : WEIGH or FIX

There are two kinds of tare subtraction procedures, one is "Direct tare", the other is "Preset tare".

1) Direct tare subtraction

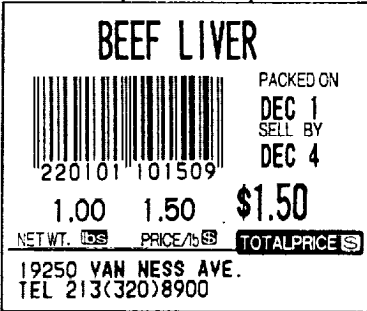
Step No.	Procedure	WEIGHT	UNIT PRICE	TOTAL PRICE	NET	DEBARACK	IN LINE	ERROR	ACCOM	ITEMS			
1	Place the tare on the platter. (ex. 0.20 lbs.)	0.20	P	000000									
2	Depress the TARE key.	0.00	P	000000	▼								
3	Weighing operation. ex.) Enter the PLU#. <table border="1" style="display: inline-table; vertical-align: middle;"><tr><td>1</td><td>0</td><td>1</td></tr></table> Depress the PLU key. Place a commodity on. Depress the PRINT key.	1	0	1	0.00	P	000101	▼					
		1	0	1									
		0.00	1.50	0.00	▼								
		1.00	1.50	1.50	▼								
 <p>BEEF LIVER PACKED ON DEC 1 SELL BY DEC 4 1.00 1.50 \$1.50 NET WT. LBS PRICE/lb \$ TOTAL PRICE \$ 19250 VAN NESS AVE. TEL 213(320)8900</p>													
4	Remove the commodity together with the tare. Tare weight is cleared automatically, then PLU data is returned to the PLU file.	0.00	P	000000									

NOTE : Tare weight subtraction is available up to 30 lbs. When tare weight subtraction is in operation, however, the scalable range for net weight is decreased by the amount of the tare.

(Net weight = Gross weight - tare weight)

2) Preset tare subtraction

Step No.	Procedure	WEIGHT	UNIT PRICE	TOTAL PRICE	NET	PREPACK	IN-LIN	ERROR	ACCM	ITEMS
1	Enter the tare weight. (ex. 0.20 lbs.)	0.00	P	000020						
2	Depress the TARE key.	- 0.20	P	000000	▼					
3	Place the tare on the platter.	0.00	P	000000	▼					
4	Weighing operation.									
5	Remove the commodity together with the tare. Tare weight is cleared automatically, then PLU data is returned to the PLU file.	0.00	P	000000						

3) Preset tare subtraction when tare weight is included in PLU data
(optional function by initial setting)

[Example] In the event that tare weight of 0.20 pounds is set for PLU#825.

Step No.	Procedure	WEIGHT	UNIT PRICE	TOTAL PRICE	NET	PREPACK	IN-LIN	ERROR	ACCM	ITEMS
1	Enter the PLU #. 8 2 5	0.00	P	000825						
2	Depress the PLU key.	- 0.20	1.25		▼					
3	If you want to change the tare weight temporarily ; Depress the TARE Key. Enter the new tare weight. Depress the TARE key.	0.00 0.30 - 0.30	1.25		▼					
4	Place the tare on the platter.	0.00	1.25	0.00	▼					
5	Weighing operation.									
6	Remove the commodity together with the tare. PLU data is returned to the PLU file.	0.00	P	000000						

13.6 SAVE KEY OPERATION SAMPLE

Control lock : REG, M.DOWN, or REWRAP
 Mode SW (2) : WEIGH, BY COUNT, or FIX

The SAVE key is used to save tare weigh, unit price, and PLU data after taking a commodity off the platter.

Step No.	Procedure	WEIGHT	UNIT PRICE	TOTAL PRICE	NET	PREPACK	PRINT	ERROR	ACCM	ITEMS
1	Place the tare on the platter. (ex. 0.20 lbs.)	0.20	P	000000						
2	Depress the TARE key.	0.00	P	000000	▼					
3	Enter the PLU#. (ex. PLU#101)	0.00	P	000101	▼					
4	Depress the PLU key.	0.00	1.50	0.00	▼					
5	Depress the SAVE key. The tare weight and PLU data are saved.	0.00	1.50	0.00	▼	▼		▼		
6	Place a commodity on. (ex. 1 lb.)	1.00	1.50	1.50	▼	▼		▼		
7	Mode SW (1) : AUTO The label is issued automatically. Mode SW (1) : MANUAL The label is issued after depressing the PRINT key.									
8	Remove the commodity together with the tare.	- 0.20	1.50		▼	▼		▼		
9	Depress the CLEAR key. Save mode is cleared.	- 0.20	1.50		▼					
10	Enter the 0. 0									
11	Depress the TARE key. The tare weight is cleared.	0.00	1.50	0.00						
12	Depress the PLU key. The scale is returned to the initial mode.	0.00	P	000000						

13.7 VOID KEY OPERATION SAMPLE

Control lock : REG, M.DOWN, or REWRAP

Mode SW (2) : WEIGH, BY COUNT, or FIX

On depressing the VOID key, the data of the last registration is subtracted from the memory.

Step No.	Procedure	WEIGHT	UNIT PRICE	TOTAL PRICE	NET	PREPACK	LINE	PRICE	ACCM	ITEMS
1	Enter the PLU#100.	0.00	P	000100						
2	Depress the PLU key.	0.00	3.00	0.00						
3	Place a commodity on the platter.	1.00	3.00	3.00						
4	Mode SW (1) : AUTO The label is issued automatically. Mode SW (1) : MANUAL The label is issued after depressing the PRINT key.									
5	Depress the VOID key. The data is subtracted from the memory.	----- 1.00	----- 3.00	----- 3.00						

13.8 DATE CHANGE

Control lock : REG, M.DOWN, or REWRAP

Mode SW (2) : WEIGH, BY COUNT, or FIX

The date can be changed temporarily.

Step No.	Procedure	WEIGHT	UNIT PRICE	TOTAL PRICE	NET	PREPACK	LINE	PRICE	ACCM	ITEMS						
1	Depress the DATE & TIME key.			120189												
2	Enter the new date. ex.) Dec. 5, 1989 <table border="1" style="margin-left: 40px;"> <tr> <td>1</td><td>2</td><td>0</td><td>5</td><td>8</td><td>9</td> </tr> </table> <div style="margin-left: 40px;"> <p>Year (00 to 99)</p> <p>Day (01 to 31)</p> <p>Month (01 to 12)</p> </div>	1	2	0	5	8	9			120589						
1	2	0	5	8	9											
3	Depress the PRINT key.	0.00	P	000000												

NOTE : The SL-5900 will check details of date input, and any wrong date will result in an error mode. The correct date should be re-entered after depressing the CLEAR key.

13.10 ENTRY BY CLERK

Control lock : REG, M.DOWN, or REWRAP

Mode SW (2) : WEIGH, BY COUNT, or FIX

The entry by clerk mode is used to print out clerk sales data on labels.

Step No.	Procedure	WEIGHT	UNIT PRICE	TOTAL PRICE	N E T	P R E P A C K	I N L I N E	A D D I T I O N	A C C M	I T E M S
1	Enter the PLU#33.	0.00	P	000033						
2	Depress the PLU key.	0.00	2.50	0.00						
3	Place a commodity on the platter.	1.00	2.50	2.50						
4	Depress the CLERK key. Depressing the CLERK key allows a receipt to be printed out.	1.00	2.50	2.50						

NOTES : 1. PLUs can also be called by using the Speed key.

2. In the entry by clerk mode, a label is manually issued and its data is recorded in the CLERK TOTAL memory, regardless of the position of switch (1).

13.11 ADD ENTRY BY CLERK

Control lock : REG

Mode SW (2) : WEIGH, BY COUNT, or FIX

The add entry by clerk mode is used to print out receipts.

Step No.	Procedure	WEIGHT	UNIT PRICE	TOTAL PRICE	NET	DISCOUNT	TAX	REMARKS	ACCM	ITEMS
1	Enter the L/R key.	0.00	P	000000					▼	
2	Enter the PLU#150.	0.00	P	000150					▼	
3	Depress the PLU key.	0.00	2.00	0.00					▼	
4	Place a commodity on the platter. ex.) Depress the CLERK key.		c1t 3	5.00					▼	▼
	Depress the ◊ key.		c1t 3	5.00					▼	▼
	Enter the PLU#20.		c1t 1	1.00					▼	▼
	Enter the VOID key.		c1t 2	4.00					▼	▼
5	Enter the PRINT key.		c1t 2	4.00					▼	▼

- NOTES :**
1. The Speed key can be used for calling the first PLU but cannot be used after pressing the ◊ key.
 2. Depressing the CLERK key causes the item total to be displayed as "SUB-TOTAL".
 3. There are three kinds of void operations:
 - 1) Item Correct Depress the CLERK key, followed by the VOID key.
 - 2) Void Deletes an item which was previously added.
 - 3) All void Depress the ◊ key, followed by the VOID key.
 4. Up to 48 items can be added in the add entry mode.

13.12 MULTIPLE WEIGHT

Control lock : REG, M.DOWN, or REWRAP

Mode SW (2) : WEIGH

This mode can be used when the option for multiple weight has been selected, and the entry unit price can be changed or the unit price is open.

Step No.	Procedure	WEIGHT	UNIT PRICE	TOTAL PRICE	NET	P P R A C K	I N L I N E	E R R O R	A C C M	I T E M S
1	Enter the PLU#60.	0.00	1 3.00	0.00						
2	Enter the Purchased Quantity. (Numeric entry = 1~9)	0.00	1 0.03	0.00						
3	Depress the FOR key.	0.00	3 0.00	0.00						
4	Enter the unit price. (ex. \$5.5)	0.00	3 5.50	0.00						
5	Place a commodity on the platter.	2.00	3 5.50	3.68						

ex) The amount for buying 2lb of a product which costs \$5.50 per 3lb is automatically calculated.

14. TOTAL OPERATION PROCEDURES

When the control lock is set to the "X" or "Z" position, it is available to issue READ or RESET reports.

When the control lock is set to the "X (READ)" position, the totals will not be cleared as they are printed on labels (for except the hourly report) or report paper.

When the control lock is set to the "Z (RESET)" position, the totals will be cleared as they are printed on labels (for except the hourly report) or report paper.

NOTE: Before printing out totals on the report paper, change the initial setting.

14.1 HOURLY TOTAL REPORT

The hourly total report is printed on report paper only.

Step No.	Procedure	WEIGHT	UNIT PRICE	TOTAL PRICE	NET	PPAPK	IN-LIN	ERR	ACCM	ITEMS
1	Enter the report #1.		-							
2	Depress the PRINT key.		1	P						

HOURLY REPORT			
READ			
MACHINE# 16		DEC/ 1/89	
STORE# 7		19:42	
HOUR	COUNT	WEIGHT	DOLLARS
15-16	69	34.93	107.45
			\$ % 17.7
16-17	45	51.75	126.41
			\$ % 20.8
17-18	48	42.48	111.40
			\$ % 18.3
18-19	12	50.83	121.56
			\$ % 20.0
19-20	93	61.88	141.47
			\$ % 23.3
TOTAL	267	241.87	608.29

14.2 GRAND TOTAL REPORT

Step No.	Procedure	WEIGHT	UNIT PRICE	TOTAL PRICE	NET	PREPACK	IN LINE	ERROR	ACCM	ITEMS
1	Enter the report #2.		-							
2	Depress the PRINT key.		2							
3	Enter the total memory #. #1 : Day total (Normal) #2 : Mark Down total #3 : Rewrap total		2 -							
			21							
			22							
			23							
4	Depress the PRINT key.		nn ←	P						

Day total :

GRAND TOTAL		
	PACKED ON	
	DEC 1	
	SELL BY	
	NO	
	236.34	390 680.20
NET WT. (LBS)	PRICE/LB (\$)	TOTAL PRICE (\$)
19250 VAN NESS AVE.		
TEL 213(320)8900		

GRAND TOTAL			
	NORMAL		READ
MACHINE# 16	DEC/ 1/89		
STORE# 7	19:37		
	COUNT	WEIGHT	DOLLARS
TOTAL	390	236.34	680.20

Mark Down total :

GRAND TOTAL		
	PACKED ON	
	DEC 1	
	SELL BY	
	NO	
	7.98	30 27.42
NET WT. (LBS)	PRICE/LB (\$)	TOTAL PRICE (\$)
19250 VAN NESS AVE.		
TEL 213(320)8900		

GRAND TOTAL			
	MARK DOWN		READ
MACHINE# 16	DEC/ 1/89		
STORE# 7	19:38		
	COUNT	WEIGHT	DOLLARS
TOTAL	30	7.98	27.42

Rewrap total :

GRAND TOTAL		
	PACKED ON	
	DEC 1	
	SELL BY	
	RO	
	7.54	999856 27.54
NET WT. (LBS)	PRICE/LB (\$)	TOTAL PRICE (\$)
19250 VAN NESS AVE.		
TEL 213(320)8900		

GRAND TOTAL			
	REWRAP		READ
MACHINE# 16	DEC/ 1/89		
STORE# 7	19:38		
	COUNT	WEIGHT	DOLLARS
TOTAL	999856	7.54	27.54

14.3 PLU TOTAL REPORT

1) Individual total

[Example] Individual PLU total (PLU#100) in the day total memory.

Step No.	Procedure	WEIGHT	UNIT PRICE	TOTAL PRICE	NET	PREPACK	IN LINE	ERROR	ACCM	ITEMS
1	Enter the report #3.		3							
2	Depress the PRINT key.		3 -							
3	Enter the total memory #1.		31							
4	Depress the PRINT key.		31 -							
5	Enter the search code 1. Code 1 : PLU# Code 2 : UPC#		311							
6	Depress the PRINT key.		311 <input type="checkbox"/>							
7	Enter the PLU#100.		311 <input type="checkbox"/>	100						
8	Depress the PRINT key.		311	P						

PLU TOTAL			
			PACKED ON
			DEC 1
			SELL BY
PLU# NO			
000100			
95.99	24	287.97	
NET WT. <input type="checkbox"/>	PRICE/lb <input type="checkbox"/>	TOTAL PRICE <input type="checkbox"/>	
19250 VAN NESS AVE.			
TEL 213(320)8900			

PLU REPORT			
PLU # 000100		NORMAL	READ
MACHINE# 16		DEC/ 1/89	
STORE# 7		19:40	
PLU #	COUNT	WEIGHT	DOLLARS \$ %
000100	T-BONE STEAK		
	24	95.99	287.97 100.0
	% OF GRAND	(DOLLARS)	62.3

2) Block total

[Example] UPC block total (UPC#250820~250829) in the mark down total memory.

Step No.	Procedure	WEIGHT	UNIT PRICE	TOTAL PRICE	NET	PREPAC	IN LINE	ERROR	ACCM	ITEMS
1	Enter the report #3.		3							
2	Depress the PRINT key.		3 -							
3	Enter the total memory #2.		32							
4	Depress the PRINT key.		32 -							
5	Enter the search code 2.		322							
6	Depress the PRINT key.		322 □							
7	Enter the UPC#25082.		322 □	25082						
8	Depress the <input type="checkbox"/> key.		322 □	25082 -						
9	Depress the PRINT key.		322	P						

NOTE : The key represents 0 through 9. Most significant digit in starting number followed by appropriate number of the keys.

PLU TOTAL

PACKED ON
DEC 1
SELL BY

UPC NO
25082-

2.66 2 6.12

NET WT. <small>lbs</small>	PRICE/lb <small>lb</small>	TOTAL PRICE <small>\$</small>
19250 VAN NESS AVE.		TEL 213(320)8900

PLU REPORT

UPC 25082- MARK DOWN READ

MACHINE# 16 DEC/ 1/89
STORE# 7 19:41

UPC COUNT	WEIGHT	DOLLARS	%
250820 2	2.66	6.12	100.0
TOTAL 2	2.66	6.12	100.0
	% OF GRAND	(DOLLARS)	22.3

3) Zone total

[Example] PLU zone total (PLU#100~303) in the rewrap total memory.

Step No.	Procedure	WEIGHT	UNIT PRICE	TOTAL PRICE	NET	PACKED ON	SELL BY	ERROR	ACCM	ITEMS
1	Enter the report #3.		-							
2	Depress the PRINT key.		3							
3	Enter the total memory #3.		3 -							
4	Depress the PRINT key.		33							
5	Enter the search code 1.		33 -							
6	Depress the PRINT key.		331							
7	Enter the start PLU#100.		331 <input type="checkbox"/>	100						
8	Depress the FOR key.		331 <input type="checkbox"/>	-						
9	Enter the end PLU#303.		331 <input type="checkbox"/>	303						
10	Depress the PRINT key.		331	P						

PLU TOTAL		
	PACKED ON	
	DEC 1	
	SELL BY	
PLU# R#		
000100-000303		
5.32	52	21.98
NET WT. (lb)	PRICE/lb	TOTAL PRICE (\$)
19250 VAN NESS AVE.		
TEL 213(320)8900		

PLU REPORT				
PLU #	000100-000303	REWRAP	READ	
MACHINE#	16	DEC/	1/89	
STORE#	7		19:42	
PLU #	COUNT	WEIGHT	DOLLARS	%
000100	T-BONE STEAK			
	2	2.66	7.98	36.3
000103	GROUND BEEF			
	2	2.66	4.00	18.2
000303	CHICKEN WING			
	48	0.00	10.00	45.5
TOTAL	52	5.32	21.98	100.0
	% OF GRAND	(DOLLARS)	79.8	

4) Entire total

[Example] Entire PLU total in the day total memory.

Step No.	Procedure	WEIGHT	UNIT PRICE	TOTAL PRICE	NET	PREPACK	IN-LIN	ERRORS	ACCM	ITEMS
1	Enter the report #3.		3							
2	Depress the PRINT key.		3 -							
3	Enter the total memory #1.		31							
4	Depress the PRINT key.		31 -							
5	Enter the search code 1.		311							
6	Depress the PRINT key twice.		311	P						

PLU TOTAL		
		PACKED ON DEC 1
		SELL BY
PLU# NO ALL		
236.34	390	680.20
NET WT. (lb)	PRICE/lb	TOTAL PRICE (\$)
19250 VAN NESS AVE. TEL 213(320)8900		

PLU REPORT				
PLU #	ALL	NORMAL	READ	
MACHINE#	16	DEC/ 1/89		
STORE#	7	19:43		
PLU #	COUNT	WEIGHT	DOLLARS	%
000031	BLUEBERRY PIE			
	6	3.54	9.70	1.4
000032	CHOCOLATE			
	MERINGUE PIE			
	7	9.42	18.84	2.8
000033	CREAM CAKE			
	4	4.33	5.41	0.8
000039	DONUTS			
	62	0.00	10.36	1.5

000303	CHICKEN WING			
	181	0.00	40.00	5.9
000820	COD STEAKS			
	2	2.66	6.12	0.9
000821	COD FILLETS			
	2	6.63	16.58	2.4
000825	SHRIMP			
	3	5.33	13.33	2.0
000826	LARGE SHRIMP			
	12	0.00	11.00	1.6
000829	SMOKED SALMON CHUNKS			
	3	15.93	35.85	5.3
999999				
	5	7.59	10.98	1.6
TOTAL	390	236.34	680.20	100.0
	% OF GRAND	(DOLLARS)	100.0	

14.4 CLERK TOTAL REPORT (for SL-5900-36 only)

1) Clerk total

This is valid only when initial set 11-1 is 1.

Step No.	Procedure	WEIGHT	UNIT PRICE	TOTAL PRICE	NET	PREPACK	INLINE	ERROR	ACCM	ITEMS
1	Enter the report #4.		-							
2	Depress the PRINT key.		4							
3	Enter the clerk memory #1.		4 -							
4	Depress the PRINT key.		41							
5	Enter the total memory #.		41 -							
	#1: Day total (Normal)		411							
	#2: Mark Down total		412							
	#3: Rewrap total		413							
6	Depress the PRINT key.		41n	P						

NOTE: When the option for label has been selected by initial set 9-2, the data for clerks 1 to 6 is printed on labels in on-demand dispensing mode (a clerk is skipped if its data is 0), and finally the gross total is printed. For report paper, the data for clerks 1 to 6 and the gross total are printed.

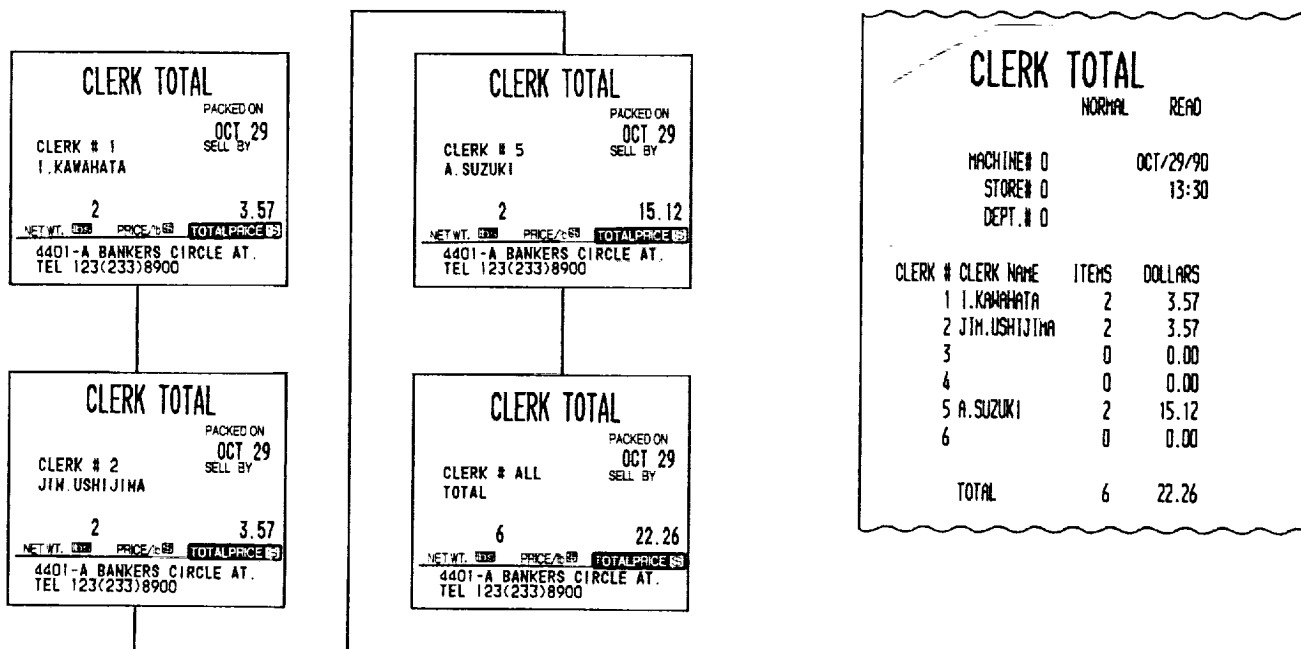

2) Clerk name

With the SL-5900, the setting PLU data can be listed on report paper when the control lock is set to the "X" position.

Step No.	Procedure	WEIGHT	UNIT PRICE	TOTAL PRICE	NET	PREPACK	INLINE	ERROR	ACCM	ITEMS
1	Enter the report #4.		-							
2	Depress the PRINT key.		4							
3	Enter the clerk memory #2.		4 -							
4	Depress the PRINT key.		42							
			42 -	p						

CLERK NAME

MACHINE# 0 OCT/29/90
STORE# 0 13:32

CLERK #	CLERK NAME
1	I.KAWAHATA
2	J.H.USHIJIMA
3	H.TOKITSU
4	S.SUZUKI
5	A.SUZUKI
6	T.ASAKA

15. LIST UP OF PLU DATA

With the SL-5900, the setting PLU data can be listed on report paper when the control lock is set to the "X" position (optional function by initial setting). Before listing, set the report paper on the label cassette and install it correctly in the scale.

Step No.	Procedure	WEIGHT	UNIT PRICE	TOTAL PRICE	NET	P P P A C K	I N L I N E	F O R	A C C M	I T E M S
			-							
1	Enter the report #51.		51							
2	Depress the PRINT key.		51	<input type="checkbox"/>						
3	Enter the PLU #.									
	ex.1) List up the individual PLU report. (PLU #100) Enter the PLU #100.		51	<input type="checkbox"/>	100					
	ex.2) List up the block PLU report. (PLU #820~829) Enter the PLU #82. Depress the <input type="checkbox"/> key.		51	<input type="checkbox"/>	82					
			51	<input type="checkbox"/>	82-					
	ex.3) List up the zone PLU report. (PLU #100~303) Enter the start PLU #100. Depress the FOR key. Enter the end PLU #303.		51	<input type="checkbox"/>	100					
			51	<input type="checkbox"/>	-					
			51	<input type="checkbox"/>	303					
	ex.4) List up the entire PLU report.		51	<input type="checkbox"/>						
4	Depress the PRINT key.		51		P					

■ Sample Reports

Ex.1) Individual PLU report

PLU PROGRAMED DATA	
PLU # 000100	
MACHINE# 16	DEC/ 1/89
STORE# 7	19:45
PLU #	COMMODITY DESCRIPTION
000100	T-BONE STEAK
	UPC 120100 \$PER / 16 3.00
	TARE 0.00 SHELF LIFE 5

Ex.3) Zone PLU report

PLU PROGRAMED DATA	
PLU # 000100-000303	
MACHINE# 16	DEC/ 1/89
STORE# 7	19:49
PLU #	COMMODITY DESCRIPTION
000100	T-BONE STEAK
	UPC 120100 \$PER / 16 3.00
	TARE 0.00 SHELF LIFE 5
000101	BEEF LIVER
	UPC 120101 \$PER / 16 1.50
	TARE 0.20 SHELF LIFE 3
000102	BEEF SIRLOIN
	SIZZLER STEAKS
	UPC 120102 \$PER / 16 3.50
	TARE 0.00 SHELF LIFE 4
000103	GROUND BEEF
	UPC 120103 \$PER / 16 OPEN
	TARE 0.00 SHELF LIFE 4
000301	HALF CHICKENS
	UPC 120301 \$PER / 16 0.75
	TARE 0.00 SHELF LIFE 4
000302	CHICKEN LEGS
	UPC 120302 \$PER / 16 3.00
	TARE 0.00 SHELF LIFE 4
000303	CHICKEN WING
	UPC 120303 \$PER / 16 2.50
	TARE 0.00 SHELF LIFE 5

Ex.2) Block PLU report

PLU PROGRAMED DATA	
PLU # 00082-	
MACHINE# 16	DEC/ 1/89
STORE# 7	19:48
PLU #	COMMODITY DESCRIPTION
000820	COD STEAKS
	UPC 250820 \$PER / 16 2.30
	TARE 0.00 SHELF LIFE 3
000821	COD FILETS
	UPC 250821 \$PER / 16 2.50
	TARE 0.00 SHELF LIFE 3
000825	SHRIMPS
	UPC 250825 \$PER/216 1.25
	TARE 0.20 SHELF LIFE 3
000826	LARGE SHRIMPS
	UPC 250826 \$PER / 16 2.75
	TARE 0.00 SHELF LIFE 4
000829	SMOKED SALMON CHUNKS
	UPC 250829 \$PER / 16 2.25
	TARE 0.00 SHELF LIFE 7

Ex.4) Entire PLU report

PLU PROGRAMED DATA			
PLU # ALL			
	MACHINE# 16	DEC/ 1/89	
	STORE# 7	19:50	
PLU #	COMMODITY DESCRIPTION		
000031	BLUEBERRY PIE		
	UPC 190031 \$PER / 16	1.75	
	TARE 0.00 SHELF LIFE	4	
000032	CHOCOLATE		
	MERINGUE PIE		
	UPC 190032 \$PER / 16	OPEN	
	TARE 0.00 SHELF LIFE	4	
000033	CREAM CAKE		
	UPC 190033 \$PER / 16	1.25	
	TARE 0.00 SHELF LIFE	3	
000039	DONUTS		
	UPC 190039 \$PER / 16	1.00	
	TARE 0.00 SHELF LIFE	3	
000100	T-BONE STEAK		
	UPC 120100 \$PER / 16	3.00	
	TARE 0.00 SHELF LIFE	5	
000101	BEEF LIVER		
	UPC 120101 \$PER / 16	1.50	
	TARE 0.20 SHELF LIFE	3	
	TARE 0.00 SHELF LIFE	4	
000301	HALF CHICKENS		
	UPC 120301 \$PER / 16	0.75	
	TARE 0.00 SHELF LIFE	4	
000302	CHICKEN LEGS		
	UPC 120302 \$PER / 16	3.00	
	TARE 0.00 SHELF LIFE	4	
000303	CHICKEN WING		
	UPC 120303 \$PER / 16	2.50	
	TARE 0.00 SHELF LIFE	5	
000820	COD STEAKS		
	UPC 250820 \$PER / 16	2.30	
	TARE 0.00 SHELF LIFE	3	
000821	COD FILETS		
	UPC 250821 \$PER / 16	2.50	
	TARE 0.00 SHELF LIFE	3	
000825	SHRIMPS		
	UPC 250825 \$PER1/216	1.25	
	TARE 0.20 SHELF LIFE	3	
000826	LARGE SHRIMPS		
	UPC 250826 \$PER / 16	2.75	
	TARE 0.00 SHELF LIFE	4	
000829	SMOKED SALMON CHUNKS		
	UPC 250829 \$PER / 16	2.25	
	TARE 0.00 SHELF LIFE	7	
999999	UPC 000000 \$PER / 16	OPEN	
	TARE 0.00 SHELF LIFE	0	

16. PROGRAMMING PROCEDURES

● Selection of Programming Menu

Step No.	Procedure	WEIGHT	UNIT PRICE	TOTAL PRICE	NET	ADDRESS	PLU	ERROR	ACCOUNT	ITEMS
1	Turn the control lock to "PROG/CMT" position.		P							
2	Select the menu #. (Refer to table 1.)		P	n	Menu #.					
3	Depress the PROG key.		Pn							
4	Start the programming.									
5	Depress the PROG key. (Finish)		P	n						
6	Return the step #2 or select another mode.									

■ Table 1 : Programming Menu Numbers and Their Functions

Menu No.	Item
0	Changing Unit Price or Price
1	Setting or Changing PLU Data
2	Setting Store Address or Commercial Message
3	Adjusting Print Position for Label
4	Setting Date, Time, Machine Number, and Store Number
5	CMT Operations
7	Changing Bar Code Format
8	Assigning Speed Keys
11	Setting Ingredient
12	Issuing Confirmation Label (for SL-5900-35/36 only)
13	Switching On-Line/Local (for SL-5900-35/36 only)
17	Setting Grade Line (for SL-5900-36 only)
18	Memory Card (for SL-5900-36 only)
20	Transmitting PLU File or Unit Price (FUN System)
21	Setting Clerk Name (for SL-5900-36 only)
40	Setting Print Item #1 ON/OFF
41	Setting Print Item #2 ON/OFF

Menu No. 0

● Changing Unit Price or Price

The unit price or price in the PLU that is previously stored can be changed with this menu.

Procedure	WEIGHT	UNIT PRICE	TOTAL PRICE	NET	PREP ACK	LINE	ERROR	ACCM	ITEMS
Menu #.		P	0						
		PROG.							
PLU#.		P0	31						
		P0	101						
		ENTER	1.50						
New unit price or price.		P0	1.25						
		P0	101						
		ENTER							
		TEST							
The setting label is issued.		PROG.							
(Select another menu or mode.)		P	0						

← The smallest PLU# in the memory is displayed.

NOTES:

1. Recalling a PLU# that has not been stored in the PLU file will result in an error.
2. It is not available to change the unit price of a PLU if it has been set to "open price".

Menu No. 1

● Setting or Changing PLU Data

Setting or changing the contents of PLU (PLU#, UPC#, Commodity Name, etc.).

Procedure	WEIGHT	UNIT PRICE	TOTAL PRICE	NET	PREPACK	INLINE	ERROR	ACCM	ITEMS
Menu #.		P	1						
		P1	1	31					
		P1	10	-----					
AUTO CODE for the UPC#.		P1	10	120					
				120---					
		P1	1						
PLU#.		P1	1	101					
		P1	2						
UPC#.		P1	2	101					
		P1	3	1 0					

(continued on next page)

← The smallest PLU# in the memory is displayed.

NOTE: UPC# is set after overwriting with the data of AUTO CODE.

ex.1) Input : 101

AUTO CODE : 120---

UPC# : 120101

ex.2) Input : 1234

AUTO CODE : 120---

UPC# : 120234

Procedure	WEIGHT	UNIT PRICE	TOTAL PRICE	NET	PREPACK	INLINE	ERROR	ACCM	ITEMS
<p>1</p> <p>Commodity name. B E E F</p> <p>2nd line setting. RETURN 1/4 SPACE 1st line setting.</p> <p>L I V E R</p> <p>ENTER</p> <p>Quantity. BY COUNT 3 In what mode is PLU used? WEIGH or FIX</p> <p>ENTER</p> <p>Unit price or price. Open price. 1 5 0</p> <p>ENTER</p> <p>Unit price flag. Q'ty > 0 Q'ty > 0 Q'ty = 0 (per lb)</p> <p>(per 1/2 lb) DELETE 1/2</p> <p>(per 1/4 lb) RETURN 1/4</p> <p>ENTER</p> <p>2</p> <p>(continued on next page)</p>		P1 3	1 4						
		P1 3	1 5						
		P 2	0						
		P1 3	1 10						
		P1 4	0						
		P1 4	3						
		P1 4	0.00						
		P1 4	1.50						
		P1 4	L-1						
		P1 4	L-2						
		P1 4	L-4						
		P1 5	0						

Procedure	WEIGHT	UNIT PRICE	TOTAL PRICE	NET	PACK	LINE	FORM	ACCM	ITEMS
<p>Shelf life.</p>		P1 5	3						
<p>Tare weight.</p>	P1 6	0.20							
		P1 7	0						
		P1 7	0						
		P1 7	1						
		P1 7	2						
		P1 1	101						
		P	1						
(Select another menu or mode.)									

NOTES:

1. The commodity name can be set in two lines. Each line can contain up to 26 characters including spaces. Before setting the second line, depress the RETURN key.
2. When the quantity is 1 or more (PLU in BY COUNT mode), the unit price flag is skipped automatically.
3. When the quantity is 1 or more (PLU in BY COUNT mode), the tare weight setting is skipped automatically even if the tare weight setting has been enabled.

■ Changing PLU Number

Procedure	WEIGHT	UNIT PRICE	TOTAL PRICE	UNIT	AMOUNT	LINE	ERROR	ACCOM	ITEMS
Menu #.		P	1						
		PROG.							
		CHANGE PLU							
Current PLU#.		P1	1	31					
		P1	9						
		3 3							
		P1	9	33					
		ENTER							
		P1	9	-					
New PLU#.		P1	9	35					
		3 5							
		P1	9	35					
		ENTER							
		P1	1	35					
		a							
		PROG.							
		P		1					
(Select another menu or mode.)									

NOTE: It is not available to change to a PLU# which has already been used in the PLU file.

■ Deleting PLU Data

Procedure		WEIGHT	UNIT PRICE	TOTAL PRICE	TAX	BACK	ENTER	ERROR	ACCM	ITEMS
Menu #.	1		P	1						
	PROG.		P1 1	31						
	DELETE PLU		P1 8							
PLU#.	1 0 3		P1 8	103						
	ENTER		P1 1	31						
	◀ a									
	PROG.									
	(Select another menu or mode.)									

NOTE: All the data programmed for PLU#103 in the PLU file is deleted. If the scale goes into error during a PLU deletion, it has not been reset or PLU# designated in the above procedure had not been preset in the PLU file.

Menu No. 2

● **Setting Store Address or Commercial Message**

With the SL-5900 scale, the store address or a commercial message can be set in the memory.

Procedure	WEIGHT	UNIT PRICE	TOTAL PRICE	UNIT	PACKAGE	LINE	ERROR	ACCM	ITEMS
Menu #. <div style="text-align: center;"> <div style="border: 1px solid black; width: 40px; height: 30px; margin: 0 auto; display: flex; align-items: center; justify-content: center;">2</div> <div style="margin: 5px 0;">↓</div> <div style="border: 1px solid black; width: 80px; height: 30px; margin: 0 auto; display: flex; align-items: center; justify-content: center;">PROG.</div> <div style="margin: 5px 0;">↓</div> <div style="border: 1px solid black; width: 160px; height: 50px; margin: 0 auto; display: flex; align-items: center; justify-content: center;"> Enter the address or commercial message. </div> <div style="margin: 5px 0;">↓</div> <div style="border: 1px solid black; width: 80px; height: 30px; margin: 0 auto; display: flex; align-items: center; justify-content: center;">PROG.</div> <p style="margin-top: 5px;">(Select another menu or mode.)</p> </div>		P	2						
		P2	1 0						
		P	2						

NOTE: The store address or a commercial message can be set in two lines. Each line can contain up to 26 characters including spaces. Before setting the second line, depress the RETURN key.

Menu No. 3

● Adjusting Print Position for Label

When a printed data position deviates from the normal position in the forward or backward direction along the label feed direction, adjust the print position using the following procedure.

Procedure	WEIGHT	UNIT PRICE	TOTAL PRICE	NET	PREPACK	INLINE	ERROR	ACCM	ITEMS
Menu #.		P	3						
Feed value. (0~199)		PROG.							
		P3 L1	100						
			Standard value						
		P3 L1	110						
			1 gradation = 1 dot = 0.154mm						
Commodity name position. (0~9)		ENTER							
		◇							
		P3 L2	5						
			Standard value						
		P3 L2	6						
			1 gradation = 3 dots = 0.462mm						
Address position. (0~9)		ENTER							
		◇							
		P3 L3	5						
			Standard value						
		P3 L3	4						
			1 gradation = 3 dots = 0.462mm						
		ENTER							
		◇							
		P3 L1	110						
		P	3						
		PROG.							
(Select another menu or mode.)									

NOTE: When the print position for a commodity name is lowered or raised, the print position for the address is also lowered or raised. After adjusting the print position for the commodity name, make sure to confirm the print position of the address.

Menu No. 4

● Setting Date, Time, Machine Number, and Store Number

Procedure	WEIGHT	UNIT PRICE	TOTAL PRICE	NET	PREPACK	INLINE	ERROR	ACCM	ITEMS
Menu #.		P	4						
4									
PROG.		P4	1	113089					
Date. (ex. Dec. 1, 1989)				12					
1 2									
Month (01~12)									
0 1				1201					
Day (01~31)									
8 9				120189					
Year (00~99)									
ENTER		P4	2	800					
Time. (ex. 15 : 30)				15					
1 5									
Hour (00~23)									
3 0				1530					
Minute (00~59)									
ENTER		P4	3						
Machine #.		P4	3	16					
1 6									
ENTER		P4	4						
Store #.		P4	4	7					
7									
ENTER		P4	5						
DEPT# MAX. 5 digits (for C4-36 only)		P4	5	18					
1 8									
ENTER		P4	1	120189					
K									
PROG.		P		4					
(Select another menu or mode.)									

NOTES:

1. Express all time in a 24 hour military format.
2. The SL-5900 will check details of date (time) input, and any wrong date (time) will result in an error mode. The correct date (time) should be re-entered after depressing the CLEAR key.

Menu No. 5

● CMT Operations

The SL-5900 is designed to interface with a Cassette Magnetic Tape loader.

The CMT loader allows the transfer of the entire PLU file from the SL-5900 to magnetic tape.

This can be accomplished in a number of operation steps. In turn, information from the magnetic tape can also be transferred to another SL-5900.

Procedure	WEIGHT	UNIT PRICE	TOTAL PRICE	NET	PREPACK	INLINE	ERROR	ACCM	ITEMS
Menu #.		P	5						
5									
PROG.		P5							
Load the tape into the CMT loader.									
SAVE (5900→CMT)		P5	1						
VERIFY (5900 = CMT)		P5	2						
LOAD (5900←CMT)		P5	3						
VERIFY (5900 = CMT = SL66)		P5	12						
LOAD (5900←CMT←SL66)		P5	13						
ENTER		P5	P	n					(n = 1~3, 12, or 13)
Rewind the Tape.									
PROG.		P	5						
(Select another menu or mode.)									

NOTES:

1. The error mode can be released by depressing the CLEAR key, and operated again through the above steps.
2. Use the metal cassette tape which is commercially available and has a capacity of 45 or 60 minutes recording.
3. For operations of the CMT loader, refer to the instruction manual provided with the CMT loader.

■ Error Code during CMT Operations

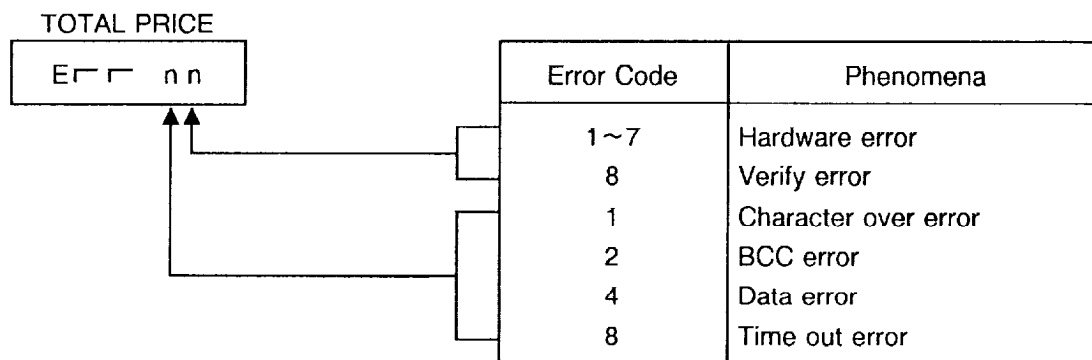

Menu No. 7

● Changing Bar Code Format

With the SL-5900 scale, three kinds of bar code formats are available : Weighing format, By Count format, and the FIX PRICE format. These formats can be changed freely.

Procedure	WEIGHT	UNIT PRICE	TOTAL PRICE	NET	PREPACK	INLINE	ERROR	ACCM	ITEMS
Menu #.		P	7						
		P7							
Menu #.		P7	1						
WEIGH mode.		P7	2						
BY COUNT mode.		P7	3						
FIX PRICE mode.		P7	6						
RECEIPT mode. (for C4-36 only)		P7	1 1	1-0					
ENTER		P7	1 3	1-0					
Switch over the setting item		P7	2 3	1-2					
Skip the digit.		P7	3 3	3-2					
		P7	4 3	3-3					
Set C1.		P7	9 3	5-1					
Set C2~C6.		P7	9 5	5-1					
		P7	1 5	1-0					
Set P1~P4.		P7							
ENTER		P	7						
PROG.									
(Select another menu or mode.)									

NOTES:

- In this scale, the previously set bar code format is cleared by RAM clear, and can be switched to the following formats. Therefore, it is necessary to set the bar code format again after RAM clear.

Bar Code Format by Initialization:

- Weighing format

0	2	C2	C3	C4	C5	C6	PC/D	P1	P2	P3	P4	C/D
---	---	----	----	----	----	----	------	----	----	----	----	-----

- By Count Format

0	0	0	C2	C3	C4	C5	0	0	0	0	C6	C/D
---	---	---	----	----	----	----	---	---	---	---	----	-----

- Fix Price Format

0	2	C2	C3	C4	C5	C6	PC/D	P1	P2	P3	P4	C/D
---	---	----	----	----	----	----	------	----	----	----	----	-----

- RECEIPT Format (for C4-36 only)

0	2	D2	D3	D4	D5	D6	PC/D	P1	P2	P3	P4	C/D
---	---	----	----	----	----	----	------	----	----	----	----	-----

- When the ENTER key is depressed, format check is executed, resulting in an error in the following cases.
 - Price check digit (PC/D) cannot be calculated.
 - Price is not set serially beginning from P1.
 - The format does not comply with the bar code format.
- Check digit (C/D) is set automatically to the digit-13.
- The usable keys to set the column are as follows:

FLAG	0	~	9
PLU#	1	~	6
UPC#	1	~	6
PC/D	1		
PRICE	1	~	6
DEPT# (for C4-36 only)	1	~	5

- Digits and display of PLU#.

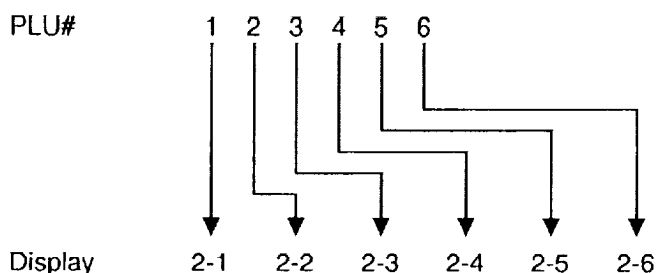

6. Digits and display of UPC#.

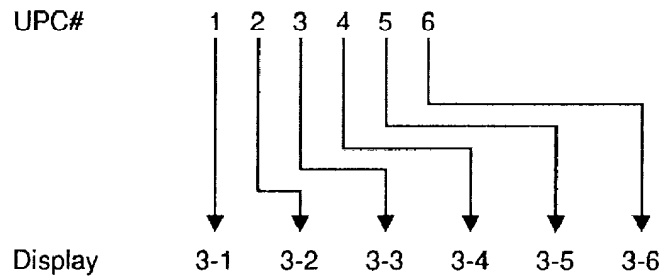

7. Digits and display of price.

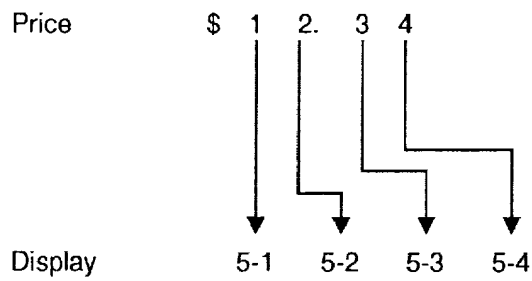

8. Digits and display of DEPT#. (for C4-36 only)

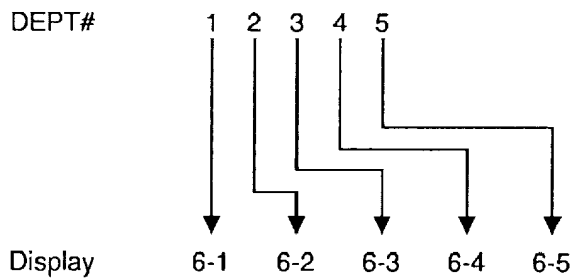

9. Setting items.

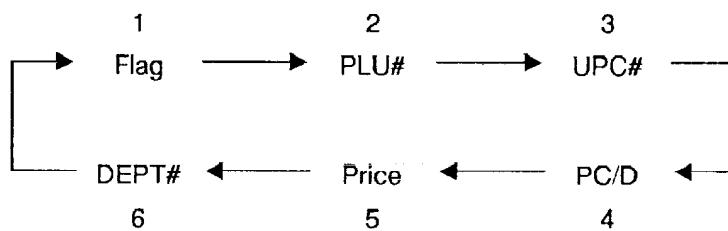

Menu No. 8

● **Assigning Speed Keys**

The SL-5900 has 60 PLU speed keys which are very convenient to call a PLU quickly.

Procedure	WEIGHT	UNIT PRICE	TOTAL PRICE	Z	R	M	D	A	M	S
<p>Menu #.</p> <div style="text-align: center; border: 1px solid black; width: 30px; margin: 0 auto; padding: 2px;">8</div> <p style="text-align: center;">↓</p> <div style="text-align: center; border: 1px solid black; width: 60px; margin: 0 auto; padding: 2px;">PROG.</div> <p style="text-align: center;">↓</p> <p>Speed key #. (1~60)</p> <div style="display: flex; justify-content: center; gap: 10px;"> <div style="border: 1px solid black; padding: 2px;">1</div> <div style="border: 1px solid black; padding: 2px;">0</div> </div> <p style="text-align: center;">↓</p> <div style="text-align: center; border: 1px solid black; width: 60px; margin: 0 auto; padding: 2px;">ENTER</div> <p style="text-align: center;">↓</p> <p>PLU#.</p> <div style="display: flex; justify-content: center; gap: 10px;"> <div style="border: 1px solid black; padding: 2px;">8</div> <div style="border: 1px solid black; padding: 2px;">2</div> <div style="border: 1px solid black; padding: 2px;">9</div> </div> <p style="text-align: center;">↓</p> <div style="text-align: center; border: 1px solid black; width: 60px; margin: 0 auto; padding: 2px;">ENTER</div> <p style="text-align: center;">↓</p> <div style="text-align: center; border: 1px solid black; width: 60px; margin: 0 auto; padding: 2px;">PROG.</div> <p style="text-align: center;">(Select another menu or mode.)</p>		<p>P</p> <p>P8</p> <p>P8</p> <p>P8 10</p> <p>P8 10</p> <p>P8</p> <p>P</p>	<p>8</p> <p>10</p> <p>829</p> <p>8</p>							

NOTE: When "0" is set on the speed key, if this speed key is pressed in the REG, MARK DOWN, or REWRAP mode, the scale enters an error mode.

Menu No. 11

● **Setting Ingredient**

Ingredient message can be printed on a label in maximum 45 characters per line, up to 6 lines with small signed letter.

Procedure	WEIGHT	UNIT PRICE	TOTAL PRICE	IN-ENT	ERROR
Menu #		P	11		
1 1					
PROG.		P11			
CLEAR		P11			
Enter the PLU#		P11	1234		
1 2 3 4					
Call the next PLU#.		P11	1235		
NEXT PLU					
Call the previous PLU#.		P11	1233		
—					
ENTER		P11	1 0		
Store the Ingredient Message.		P11	1 12		
SEND					
Call the Stored Ingredient Message.		P11	1 12		
RECEIVE					
Commodity Name		P11	1 4		
B U T T E R					
Set the data on the second line and subsequent.					
RETURN 1/4					
ENTER		P11	1234		
PROG.		P	11		
(Select another menu or mode.)					

- NOTES:**
1. *Ingredient data cannot be saved into CMT, PL-3 and RAM card for the TEC SL66.*
 2. *This setting function can be used only after designating the PLU# by initial set 9-6, 7 and 8, and selecting RAM capacity by initial set 14-4 and 5 to secure a memory space. Data may be damaged if the initial set is changed during ingredient setting.*

Initial Set 9

8	7	6	PLU#
0	0	0	400
0	0	1	680
0	1	0	960
0	1	1	1240

Initial Set 14

5	4	RAM Capacity
0	0	PLU 1240/Ing. 0
0	1	PLU 960/Ing. 116
1	0	PLU 680/Ing. 232
1	1	PLU 400/Ing. 348

3. When no data is programmed for the PLU, ingredient cannot be set.
4. "PLU NOT FOUND" error occurs when PLU# not registered is entered.
5. The ingredient to be used for SEND or RECEIVE is cleared when entering this mode.
6. "MEMORY FULL" error occurs when there is no memory space to register ingredient data.
7. Plural PLUs cannot use same ingredient data. (PLU and ingredient data are in pairs.)
8. Any terminal in FUN System can transfer PLU and its ingredient data in pairs to other terminals.

Menu No. 12

● Issuing Confirmation Label (for SL-5900-35/36 only)

Test labels used to confirm that a PLU previously present to this scale is present in the master file of the POS system, can be issued.

Procedure	WEIGHT	UNIT PRICE	TOTAL PRICE	NET	PREPAC	LINE	ERROR	ACCM	ITEMS
<p>Menu #.</p> <div style="border: 1px solid black; padding: 2px; display: inline-block; margin-bottom: 5px;">1 2</div> <p style="margin-left: 20px;">↓</p> <div style="border: 1px solid black; padding: 2px; display: inline-block; margin-bottom: 5px;">PROG.</div> <p style="margin-left: 20px;">↓</p> <p>Set the individual PLU #.</p> <div style="border: 1px solid black; padding: 2px; display: inline-block; margin-bottom: 5px;">1 0 0</div> <p style="margin-left: 20px;">→</p> <p>Set the block PLU #. (Ex. 820~829)</p> <div style="border: 1px solid black; padding: 2px; display: inline-block; margin-bottom: 5px;">8 2 ◊</div> <p style="margin-left: 20px;">→</p> <p>Set the zone PLU #. (Ex. 100~303)</p> <div style="border: 1px solid black; padding: 2px; display: inline-block; margin-bottom: 5px;">1 0 0</div> <p style="margin-left: 20px;">→</p> <p>Set the entire PLU #.</p> <div style="border: 1px solid black; padding: 2px; display: inline-block; margin-bottom: 5px;">NEXT PLU 3 0 3</div> <p style="margin-left: 20px;">→</p> <p style="margin-left: 20px;">↓</p> <div style="border: 1px solid black; padding: 2px; display: inline-block; margin-bottom: 5px;">ENTER</div> <p style="margin-left: 20px;">↓</p> <div style="border: 1px solid black; padding: 2px; display: inline-block; margin-bottom: 5px;">The confirmation labels are issued.</div> <p style="margin-left: 20px;">↓</p> <p>To interrupt label issue.</p> <div style="border: 1px solid black; padding: 2px; display: inline-block; margin-bottom: 5px;">CLEAR</div> <p style="margin-left: 20px;">↓</p> <p>To resume label issue which has been interrupted.</p> <div style="border: 1px solid black; padding: 2px; display: inline-block; margin-bottom: 5px;">ENTER</div> <p style="margin-left: 20px;">→</p> <p>To cancel label issue which has been interrupted.</p> <div style="border: 1px solid black; padding: 2px; display: inline-block; margin-bottom: 5px;">CLEAR</div> <p style="margin-left: 20px;">→</p> <p style="margin-left: 20px;">↓</p> <div style="border: 1px solid black; padding: 2px; display: inline-block; margin-bottom: 5px;">PROG.</div> <p style="margin-left: 20px;">↓</p> <p>(Select another menu or mode.)</p>		P	12						
		P12							
		P12	100						
		P12	82-						
		P12	100						
		P12	303						
		P	12						

Menu No. 13

● **Switching On-Line/Local (for SL-5900-35/36 only)**

When the SL-5900-35 is used as a satellite in an on-line system, the "ID No." and "Transmission Delay Time" must be set by the following procedure.

Procedure	WEIGHT	UNIT PRICE	TOTAL PRICE	NET	PREP ACK	IN LINE	ERROR	ACCM	ITEMS
Menu #.		P	13						
		P130F							
Switch the using mode of the scale.		P13t3	ld						
Enter the ID #. (0~255)		P13t3	ld	50					
		P13t3	tr						
Select the transmission delay time (1~9). (Refer to table 2)		P13t3	tr	3					
		P13t3	ld	50					
		P	13						
(Select another menu or mode.)									

NOTE: The TMCC-3 baud rate can only be 4800 BPS.

■ **Table 2 : Transmission Delay Time Table**

	TR-Time (ms)		TR-Time (ms)
1	20	6	120
2	40	7	140
3	60	8	160
4	80	9	180
5	100		

Menu No. 17

● **Setting Grade Line (for SL-5900-36 only)**

You can set the maximum 49 kinds of grade line (26 character per line), and call one of them to print it to on the label.

Procedure	WEIGHT	UNIT PRICE	TOTAL PRICE	NET	ALUMINUM	IRON	ERROR	ACCUM	ITEMS
Menu #.		P	17						
<div style="border: 1px solid black; display: inline-block; padding: 2px;">1</div> <div style="border: 1px solid black; display: inline-block; padding: 2px;">7</div>		P17							
<div style="border: 1px solid black; display: inline-block; padding: 2px;">PROG.</div>		P17	10						
<div style="border: 1px solid black; display: inline-block; padding: 2px;">1</div> <div style="border: 1px solid black; display: inline-block; padding: 2px;">0</div>		P17							
<div style="border: 1px solid black; display: inline-block; padding: 2px;">ENTER</div>		P17	11						
Enter the grade line #. (1~49) <div style="border: 1px solid black; display: inline-block; padding: 2px;">Enter the characters. (max. 26 chara./line)</div>		P17							
<div style="border: 1px solid black; display: inline-block; padding: 2px;">ENTER</div>		P17							
<div style="border: 1px solid black; display: inline-block; padding: 2px;">PROG.</div>		P17							

Menu No. 18

● **Memory Card (for SL-5900-36 only)**

PLUs are saved, compared, and loaded by using the memory card (128KB).

Procedure	WEIGHT	UNIT PRICE	TOTAL PRICE	NET	P X C O U N T E R	I N L I N E	E R R O R	A C C O U N T	I T E M S
Menu #.		P	18						
		P18							
Save		P18	1						
Compare		P18	2						
Load		P18	3						
Data display		P18	20						
		P18	CHARGE						
		P18	1						
		↓							
		P18							
Format clear		P18	80						
PLU clear		P18	98						
		P18	SAVE						
		P18	n						
		↓							
		P18							

- NOTES: 1. If the PLU file cannot be saved into one memory card, the program will display the message "INS NAOTHER CARD".
Then, replace the memory card and press the ENTER key so that the following data will be saved. For cancellation, press the CLEAR key.
2. Comparison of the PLUs stored in the memory card and those in the scale terminates normally even if other PLUs are left in the scale memory. Even if the PLU data of the scale ends, a data error results if other data is left in the memory card.
3. Of the PLUs stored in the memory card in loading the PLU file, the data found in the scale memory is overwritten and the data not found in it is added.

● Error Information

Error Information		Input Key No.						Error Title
		1	2	3	20	80	98	
Error Information 1	No memory card is found or the card is defective.	<input type="radio"/>	<input type="radio"/>	<input type="radio"/>	<input type="radio"/>	<input type="radio"/>		MEMORY CARD N.G.
	Unformatted or battery error.	<input type="radio"/>	<input type="radio"/>	<input type="radio"/>	<input type="radio"/>			NO FORMAT OR BATT
	The card disappeared in the middle of processing.	<input type="radio"/>	<input type="radio"/>	<input type="radio"/>				NO MEMORY CARD
	The memory card is full (nothing has been saved).	<input type="radio"/>						MEMORY CARD FULL
Error Information 2	Format error (no PLU file is found in the memory card.)	<input type="radio"/>	<input type="radio"/>					FORMAT ERROR
	Data Error	<input type="radio"/>						DATA ERROR
	No. of logos mismatched							DIFF. # OF DATA

Menu No. 20

● **Transmitting PLU File or Unit Price (FUN System)**

Any terminal in the FUN system can transfer the data of its PLU file or unit price to other terminals for verification. In this case, the destination terminal (s) must be set in the REG mode.

Procedure	WEIGHT	UNIT PRICE	TOTAL PRICE	NET	PREPACK	INLINE	ERROR	ACCM	ITEMS
Menu #.		P	20						
		P20							
Transmit PLU file.		P20	1						
Transmit unit price.		P20	2						
Verify PLU file.		P20	11						
Verify unit price.		P20	12						
		P20		P					
		P20		↓					
		P	20						

```

graph TD
    A[Menu #.] --> B[2 | 0]
    B --> C[PROG.]
    C --> D[ ]
    D --> E[1]
    D --> F[2]
    D --> G[1 | 1]
    D --> H[1 | 2]
    E --> I[ ]
    F --> I
    G --> I
    H --> I
    I --> J[ENTER]
    J --> K[PROG.]
    J --> D
    K --> L["(Select another menu or mode.)"]
  
```

NOTES:

1. When the PLU data has been changed using menu #1 and the data is to be transferred to other terminals through the operating procedure described above, the PLU file transfer is performed.
2. When the unit price has been changed using menu #0 and the unit price is to be transferred to other terminals through the operating procedure described above, the unit price transfer is performed.
3. While receiving data, the terminals stop all operations.

Menu No. 21

● Setting Clerk Name (for SL-5900-36 only)

Procedure	WEIGHT	UNIT PRICE	TOTAL PRICE	NET	PREPACK	LINE	ERROR	ACCM	ITEMS
Menu #.		P	21						
	<div style="display: flex; justify-content: space-around;"> 2 1 </div>								
	<div style="border: 1px solid black; padding: 2px; width: fit-content; margin: 0 auto;">PROG.</div>	P21	.						
No. of Clerks Max. 6	<div style="display: flex; flex-direction: column; align-items: center;"> <div style="display: flex; justify-content: space-between; width: 100%;"> 1 → </div> <div style="display: flex; justify-content: space-between; width: 100%;"> 2 → </div> <div style="display: flex; justify-content: space-between; width: 100%;"> 3 → </div> <div style="display: flex; justify-content: space-between; width: 100%;"> 4 → </div> <div style="display: flex; justify-content: space-between; width: 100%;"> 5 → </div> <div style="display: flex; justify-content: space-between; width: 100%;"> 6 → </div> </div>	P21	1						
		P21	2						
		P21	3						
		P21	4						
		P21	5						
		P21	6						
No. of Characters Max. 12	<div style="display: flex; flex-direction: column; align-items: center;"> <div style="border: 1px solid black; padding: 2px; width: fit-content;">CLEAR</div> <div style="border: 1px solid black; padding: 2px; width: fit-content; margin-top: 5px;">ENTER</div> <div style="border: 1px solid black; padding: 2px; width: fit-content; margin-top: 5px;">Program clerk name</div> <div style="border: 1px solid black; padding: 2px; width: fit-content; margin-top: 5px;">ENTER</div> <div style="border: 1px solid black; padding: 2px; width: fit-content; margin-top: 5px;">PROG.</div> </div>								
		P21							
		P21							

■ Error Code during Transmitting

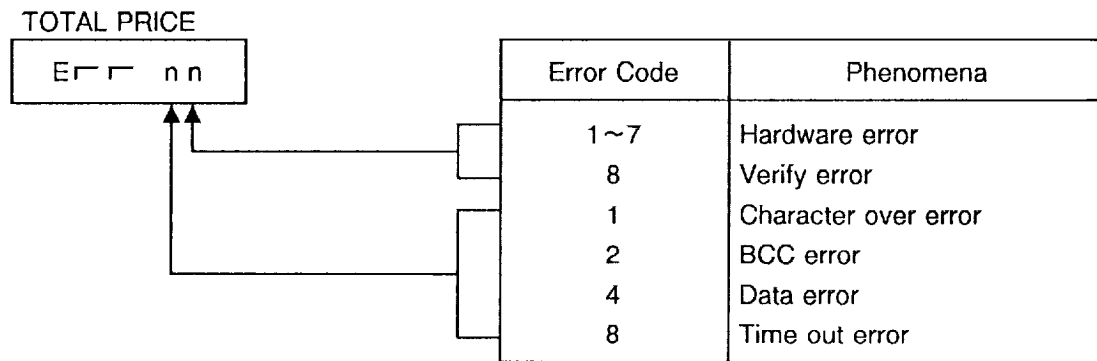

All errors occur in the receiving terminal. The error mode can be released by depressing the CLEAR key, then attempt to transmit again.

Menu No. 40

● **Setting Print Item #1 ON/OFF**

The setting specifies whether each print item on the registered labels is to be printed or not.

Procedure	WEIGHT	UNIT PRICE	TOTAL PRICE	NET	PREPACK	INLINE	ERROR	ACCM	ITEMS
Menu #. <div style="display: flex; justify-content: center; gap: 10px;"> <div style="border: 1px solid black; padding: 2px 5px;">4</div> <div style="border: 1px solid black; padding: 2px 5px;">0</div> </div> <div style="text-align: center; margin-top: 5px;"> <div style="border: 1px solid black; padding: 2px 5px;">PROG.</div> </div> <div style="display: flex; align-items: center; margin-top: 10px;"> <div style="border: 1px solid black; padding: 5px; width: 150px; height: 150px; position: relative;"> <div style="position: absolute; top: 0; left: 0; right: 0; bottom: 0; border: 1px solid black;"></div> </div> <div style="margin-left: 10px;"> <div style="border: 1px solid black; padding: 2px 5px; margin-bottom: 10px;">1</div> <div style="border: 1px solid black; padding: 2px 5px; margin-bottom: 10px;">2</div> <div style="border: 1px solid black; padding: 2px 5px; margin-bottom: 10px;">3</div> <div style="border: 1px solid black; padding: 2px 5px; margin-bottom: 10px;">4</div> <div style="border: 1px solid black; padding: 2px 5px;">5</div> </div> </div> <div style="text-align: center; margin-top: 10px;"> <div style="border: 1px solid black; padding: 2px 5px;">PROG.</div> <p style="font-size: small;">(Select another menu or mode.)</p> </div>		P	40						
Packed on date.		P40	00000						
Sell by date.		P40	00001						
Commodity name.		P40	00010						
Address.		P40	00100						
Bar Code.		P40	01000						
		P40	10000						
		P	40						

[Position of Print Item]

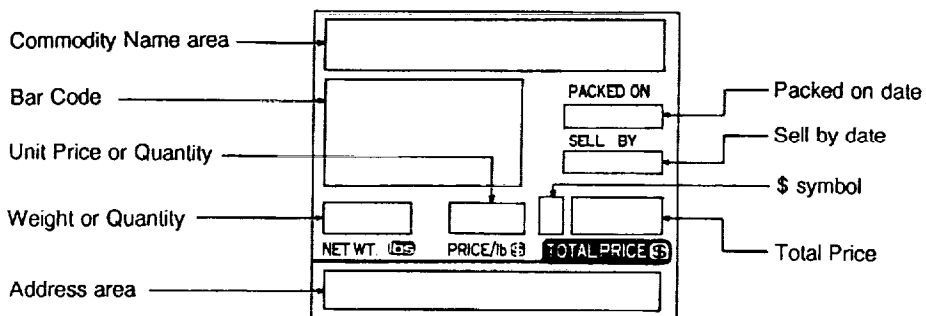

Menu No. 41

● **Setting Print Item #2 ON/OFF**

The setting specifies whether each print item on the registered labels is to be printed or not.

Procedure	WEIGHT	UNIT PRICE	TOTAL PRICE	NET	PREPACK	INLINE	ERROR	ACCM	ITEMS
Menu #.		P	41						
		P41	00000						
Unit price.		P41	00001						
Weight.		P41	00010						
Total price.		P41	00100						
\$ symbol.		P41	01000						
Quantity.		P41	10000						
		P	41						

```

graph TD
    A["4 | 1"] --> B[PROG.]
    B --> C[ ]
    subgraph C [ ]
        direction TB
        C1[1]
        C2[2]
        C3[3]
        C4[4]
        C5[5]
    end
    C --> C1
    C --> C2
    C --> C3
    C --> C4
    C --> C5
    C1 --> D[PROG.]
    D --> E["(Select another menu or mode.)"]
    
```

17. ERROR MESSAGE TABLE

Take the following action if an error message has appeared on the total price display and/or message display (option) with the buzzer sounding.

Message	Cause	Solution
H HEAD FAILURE	Print head is not properly set.	Depress the CLEAR key, and set the print head.
L LABEL END	The label has run out. The label is not placed over the label end sensors.	Depress the CLEAR key, and set a new label roll. Depress the CLEAR key, and set the label correctly.
P PRT FAILURE	Printer trouble.	Check that the label and print head are set correctly. If the label home position is misaligned, depress the FEED key.
DATA ENTRY ERROR	Error in key input.	Depress the CLEAR key, and re-input the right data.
PLU NOT FOUND	The PLU# being called out is not registered.	Depress the CLEAR key, and check the PLU data.
PLU NOT RESET	Attempt is made to change the PLU data without executing the reset total operation.	Depress the CLEAR key, and execute the reset total operation.
MEMORY FULL	No memory space to set PLU.	Depress the CLEAR key, and set after deleting unwanted PLU.
CHARACT. OVERRUN	Attempt is made to set more than maximum allowed number of characters.	Depress the CLEAR key, and re-input the right data.
TOTALS OVERFLOW	Total memory has overflowed at the time of issuing a label.	Depress the CLEAR key, and turn the control lock at "Z" position. Then sum up the overflowing memory.
PLU DATA ERROR	Error of PLU data.	Depress the CLEAR key, and check the PLU data.
LABEL OVERRUN	Label overrun.	Depress the CLEAR key and the FEED key. Then remove the label.
oP OPTION RAM ERROR	The RAM quantity initial set data is different from the actual number of RAMs.	Call for service.

■ CMT/FUN

Message	Cause	Solution
HARD ERROR	Hardware error.	Depress the CLEAR key.
DATA ERROR	Data error.	Depress the CLEAR key.
TIME OUT ERROR	Time out error.	Depress the CLEAR key.
BAD TAPE OR CMT	Bad tape or CMT loader. (Hardware error)	Depress the CLEAR key, and change the tape or CMT loader.

18. BEFORE YOU CALL FOR SERVICE

It is our primary concern to give you full satisfaction and better service. If, however, any problem arises in connection with the operation of this scale, please check the following points before calling for service:

- A) Is the power plug fully plugged into an AC outlet?
- B) Is the power turned ON?
- C) Is AC power being properly supplied to the outlet? (Check it using another electric appliance.)
- D) Check the circuit breaker.
- E) Has there been a power failure of any sort?
- F) Has the operation been carried out in the correct order?

This scale has been manufactured under strict quality control. If you have any trouble, however, DO NOT ATTEMPT TO FIX IT BY YOURSELF. Pull the power plug out of the outlet, and contact your TEC representative.

NOTE: The specifications are subject to change without notice.

